



DDR-45-xxP



DDR-45-xxST



DDR-45-xxDR



TPTC004



## Features

- 150~1500Vdc 10:1 ultra-wide input range
- 4KVac I/O high isolation(Reinforced isolation)
- Protections: Short circuit / Overload / Over voltage / DC input under voltage / DC input reverse Polarity
- Fanless design, fully encapsulated, cooling by free air convection
- Can be installed on DIN rail TS-35/7.5 or 15 (DR-Type)
- -40~+80°C ultra-wide operating temperature (> +50°C derating)
- Operating altitude up to 5000 meters
- 3 years warranty

## Applications

- Photovoltaic power generation
- Renewable Energy System
- High voltage frequency conversion
- Industrial control system
- Semiconductor fabrication equipment
- Electro-mechanical apparatus
- DC bus centralized application
- Energy storage system(ESS)
- Charging pile
- Third rail

## GTIN CODE

MW Search: <https://www.meanwell.com/serviceGTIN.aspx>

## Description

DDRH-45 series is a 150 ~ 1500Vdc high reliable ultra-high input DC-DC converter which can supply stable working voltage for the load. Main features are as following: compact size, -40~+80°C wide range operating temperature, 4KVac high isolation voltage, operation at 5000m altitude, low ripple & noise, complete protections and so on. Furthermore, this series also has DIN Rail type, it is suitable to be mounted on TS-35/7.5 or TS-35/15 rails. DDRH-45 is designed to meet UL1741(By requested) and IEC62109-1 standard. It is suitable for industrial automation, surveillance, telecommunication and can be widely deployed in the applications of new energy generation such as solar power, and windmill power generation, for instances, photovoltaic power systems, high voltage inverting , DC bus centralized application, ESS, charging pile, railway and so forth.

## Model Encoding

DDRH - 45 - 12 P

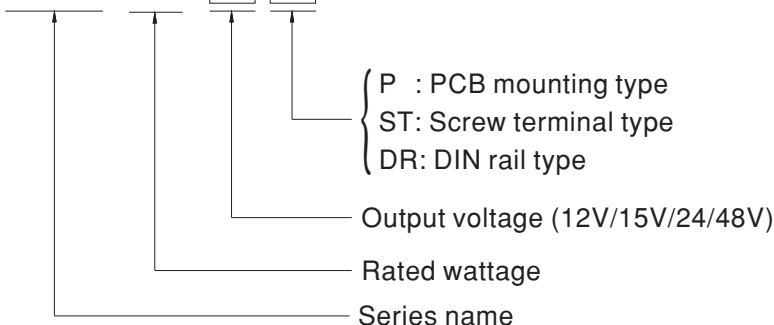



MODEL SELECTION TABLE							
ORDER NO.	INPUT			OUTPUT		EFFICIENCY (Typ.)	CAPACITOR LOAD (MAX.)
	INPUT VOLTAGE (RANGE)	INPUT CURRENT		OUTPUT VOLTAGE	OUTPUT CURRENT		
		NO LOAD	FULL LOAD				
DDRH-45-12 □	Nominal 800Vdc (150~1500Vdc)	0.2mA	75mA	12V	3.75A	85%	3750μF
DDRH-45-15 □		0.2mA	75mA	15V	3A	85%	3000μF
DDRH-45-24 □		0.2mA	75mA	24V	1.87A	86%	1870μF
DDRH-45-48 □		0.2mA	75mA	48V	0.938A	86%	938μF

□ = P, ST, DR

SPECIFICATION				
INPUT	VOLTAGE RANGE		150 ~ 1500Vdc	
	FILTER		Pi type	
	EXTERNAL INPUT FUSE		4A/1500Vdc, required (Please refer to page 6 for more details)	
	INRUSH CURRENT (Typ.)		Cold start 150A max. @ Vin=800Vdc	
OUTPUT	VOLTAGE ACCURACY		±2.0%	
	RATED POWER		45W	
	RIPPLE & NOISE <small>Note.2</small>		12 ~ 24Vo: 100mVp-p    48Vo: 150mVp-p	
	LINE REGULATION		±1%	
	LOAD REGULATION		±1% (10% Load to Full Load)	
	SWITCHING FREQUENCY (Typ.)		28 ~ 75.6KHz	
	HOLD UP TIME		20ms min. @Vin=800Vdc	
SETUP TIME		2s max. @150~1500Vdc		
PROTECTION	SHORT CIRCUIT			
	OVERLOAD			
	OVER VOLTAGE			
	DC INPUT	REVERSE POLARITY		By internal Bridge Diode, no damage, recovers automatically after fault condition removed
		UNDER VOLTAGE LOCKOUT		Start-up voltage    132Vdc Shutdown voltage    121Vdc
ENVIRONMENT	WORKING TEMP. <small>Note.3</small>		-40 ~ +80°C (Refer to "Derating Curve")	
	WORKING HUMIDITY		20% ~ 90% RH non-condensing	
	STORAGE TEMP., HUMIDITY		-40 ~ +85°C, 10 ~ 95% RH non-condensing	
	TEMP. COEFFICIENT		±0.02% / °C (-40°C ~ 50°C) Typ.	
	VIBRATION		Meets: MIL.STD-810F Table 514.5C-VIII, 15-2000Hz, X,Y,Z axis, 1hr (each axis), total 3hrs	
	OPERATING ALTITUDE <small>Note.4</small>		5000 meters	
	OVER VOLTAGE CATEGORY		II ; According to EN62109-1; altitude up to 5000 meters	
SAFETY & EMC (Note.5)	SAFETY STANDARDS			
	WITHSTAND VOLTAGE			
	ISOLATION RESISTANCE			
	EMC EMISSION	Parameter		Standard
		Conducted		BS EN/EN55032
		Radiated		BS EN/EN55032
	EMC IMMUNITY	BS EN/EN55035		
		Parameter		Standard
		ESD		BS EN/EN61000-4-2
		Radiated Susceptibility		BS EN/EN61000-4-3
EFT/Bursts		BS EN/EN61000-4-4		
Surge		BS EN/EN61000-4-5		
Conducted		BS EN/EN61000-4-6		
OTHERS	MTBF			
	DIMENSION (L*W*H)			
	CASE MATERIAL			
	POTTING MATERIAL			
	PIN MATERIAL			
	PACKING			
NOTE	<ol style="list-style-type: none"> <li>All parameters NOT specially mentioned are measured at 800Vdc input, rated load and 25°C of ambient temperature.</li> <li>Ripple &amp; noise are measured at 20MHz of bandwidth by using a 12" twisted pair-wire terminated with a 0.1µf &amp; 47µf parallel capacitor.</li> <li>Derating may be needed under low input voltage. Please check the derating curve for more details.</li> <li>The ambient temperature derating of 3.5°C/1000m with fanless models and of 5°C/1000m with fan models for operating altitude higher than 2000m(6500ft).</li> <li>The power supply is considered a component which will be installed into a final equipment. The final equipment must be re-confirmed that it still meets EMC directives. For guidance on how to perform these EMC tests, please refer to "EMI testing of component power supplies." (as available on <a href="http://www.meanwell.com">http://www.meanwell.com</a>)</li> </ol> <p>※ Product Liability Disclaimer : For detailed information, please refer to <a href="https://www.meanwell.com/serviceDisclaimer.aspx">https://www.meanwell.com/serviceDisclaimer.aspx</a></p>			

### Derating Curve

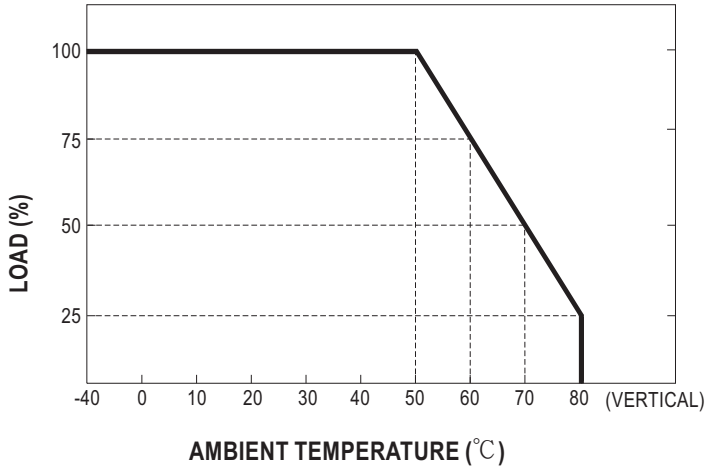

### Mechanical Specification

- All dimensions in mm(inch)
- Tolerance:  $x.xx \pm 0.03\text{mm}$  ( $x.x \pm 0.01''$ )  
 $x.xxx \pm 0.02\text{mm}$  ( $x.xx \pm 0.00078''$ )
- Pin size is:  $x.x \pm 0.7\text{mm}$  ( $x.x \pm 0.0275''$ )  
 $x.xx \pm 0.5\text{mm}$  ( $x.x \pm 0.0196''$ )

### DDRH-45-xxP (PCB Mounting Type)

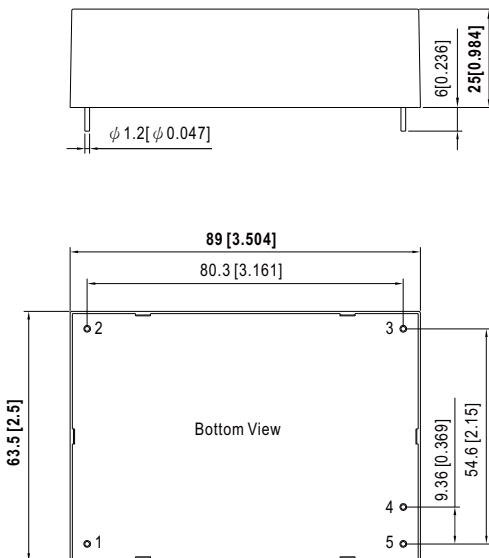

### Plug Assignment

Pin-Out	
Pin No.	Output
1	-Vin
2	+Vin
3	NC
4	-Vout
5	+Vout

### DDRH-45-xxST (Screw Terminal Type)

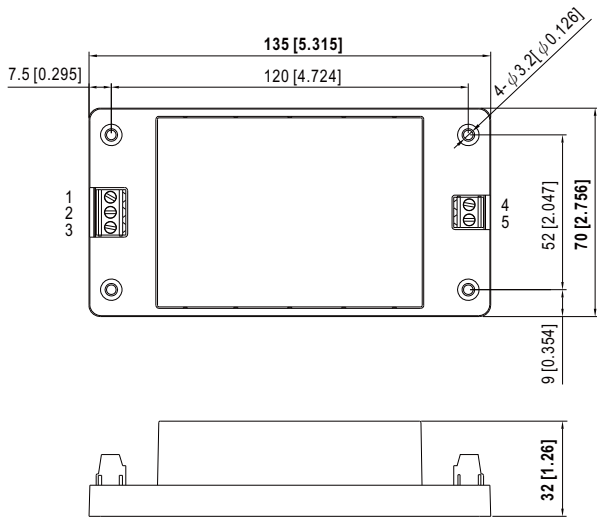

#### Terminal Pin No. Assignment

Pin-Out		
Pin No.	Output	Mating wire
1	-Vin	12~24AWG
2	NC	
3	+Vin	
4	+Vout	
5	-Vout	

Note: Recommended torque setting for terminal is 5kgf-cm(4.4 Lb-in)

### DDRH-45-xxDR (DIN Rail Type)

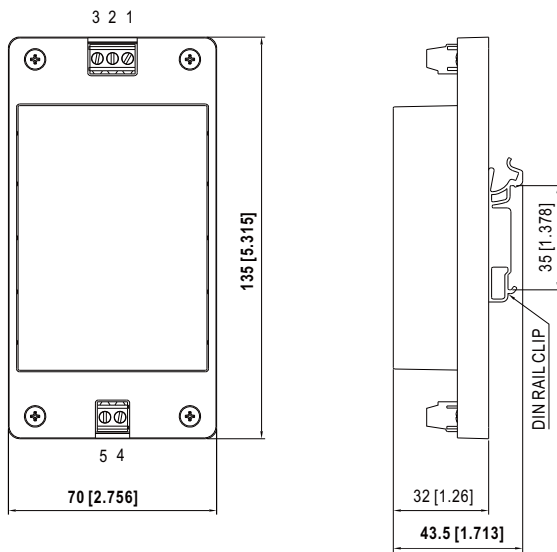

#### Terminal Pin No. Assignment

Pin-Out		
Pin No.	Output	Mating wire
1	-Vin	12~24AWG
2	NC	
3	+Vin	
4	+Vout	
5	-Vout	

Note: Recommended torque setting for terminal is 5kgf-cm(4.4 Lb-in)

#### Installation Instruction(DDRH-45-xxDR only)

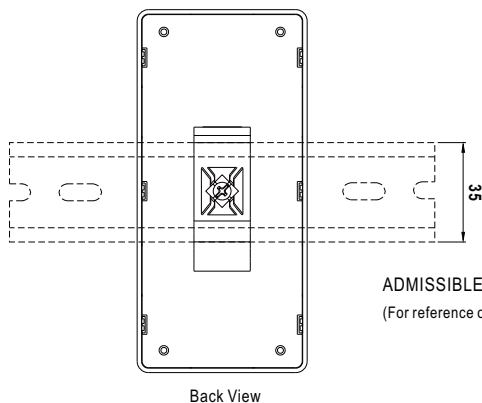

ADMISSIBLE DIN-RAIL: TS35/7.5 or TS35/15  
 (For reference only. Not included with unit.)

### EMC Suggestion Circuit

※EMI test standard: BS EN/EN55032 Class A conducted and radiated emission are as below:

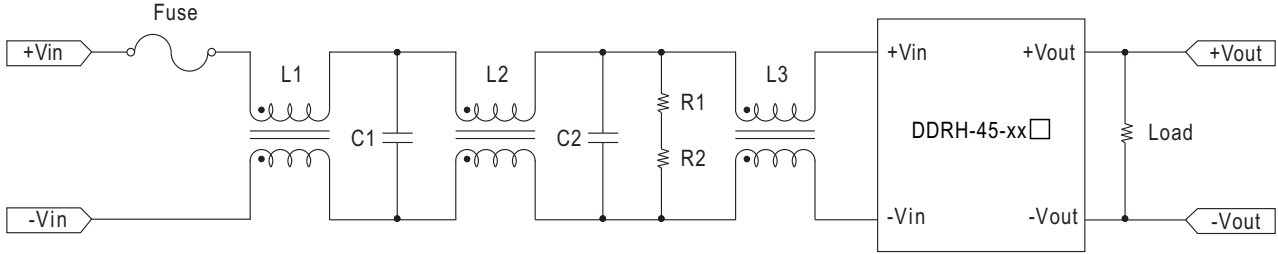

Model No.	BS EN/EN55032 Class A			
	Fuse	L1,L2,L3	C1,C2	R1,R2
DDRH-45-xxP	4A/1500Vdc	Common choke 20mH SQ1515	0.33μF/1500Vdc	1/2W 3M, ≥800V
DDRH-45-xxST				
DDRH-45-xxDR				

### External Fuse Wiring Instruction

External FUSE is required. FUSE specification: 4A/1500Vdc.

Suggested model:

Fuse Brand	Manufacturer Part NO.		MW's Order NO.
	Fuse	Fuse Holder	Fuse + Fuse Holder
WalterFuse	WJ30-4	WJ30-H	<a href="#">WJ30-4_WJ30-H</a>

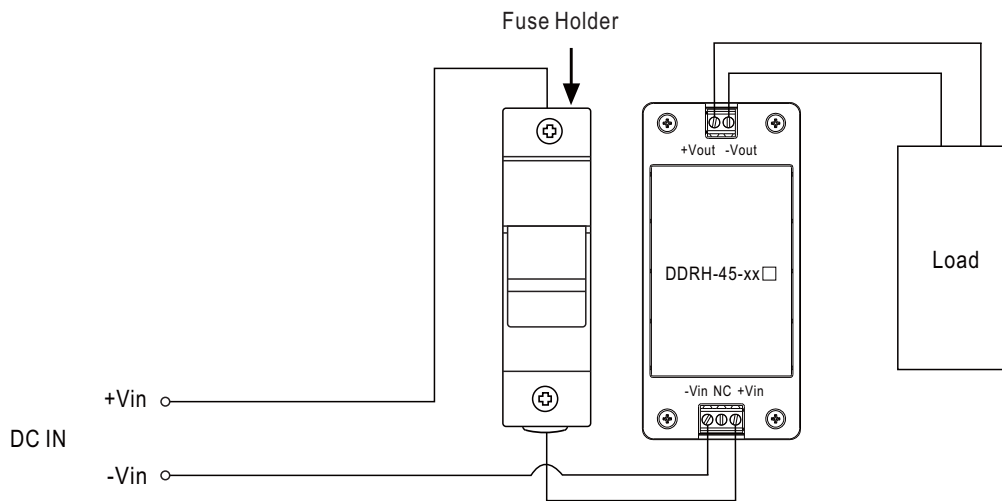

**Packing**

Standard Packing	DDRH-45-xxP			
	MPQ Per Tray(PCS)	One Tray G.W.	Max. Q'TY/ Carton(PCS)	One Carton G.W.
<p>Unit : mm</p> <p>DDRH-45-xxP</p> <p>Antistatic Plastic blister</p> <p>Antistatic Plastic blister</p> <p>Antistatic Foam</p> <p>CARTON L400x W320 x H225</p>	6	1.66Kg	18	6Kg

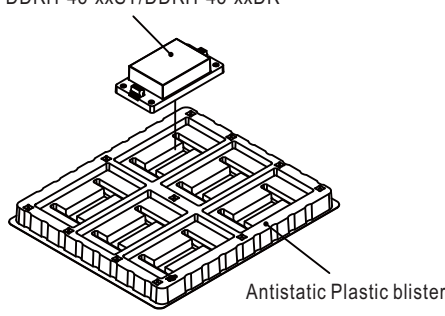
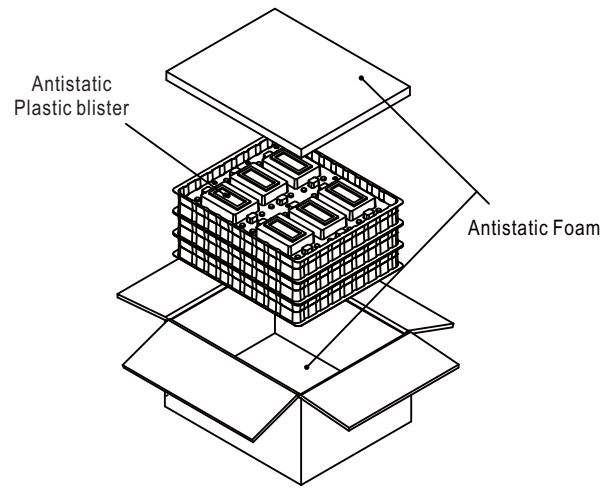
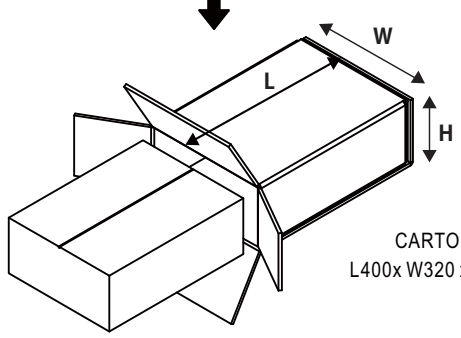
Standard Packing	DDRH-45-xxST			
	MPQ Per Tray(PCS)	One Tray G.W.	Max. Q'TY/ Carton(PCS)	One Carton G.W.
<p>Unit : mm</p> <p>DDRH-45-xxST/DDRH-45-xxDR</p>  <p>Antistatic Plastic blister</p> <p>↓</p>  <p>Antistatic Plastic blister</p> <p>Antistatic Foam</p> <p>↓</p>  <p>CARTON L400x W320 x H225</p>	6	2Kg	18	7Kg
	DDRH-45-xxDR			
	MPQ Per Tray(PCS)	One Tray G.W.	Max. Q'TY/ Carton(PCS)	One Carton G.W.
	6	2.03Kg	18	7.1Kg

■ Installation Manual

Please refer to : <http://www.meanwell.com/manual.html>