



# Test Report: HLG-240H-C1400

---

250W Single Output LED Power Supply

## ■ DESIGN VERIFY TEST

Output Function Test

Input Function Test

Protection Function Test

Component Stress Test

## ■ SAFETY & E.M.C. TEST

Safety Test

E.M.C. Test

## ■ RELIABILITY TEST

ENVIRONMENT TEST

## DESIGN VERIFY TEST

### OUTPUT FUNCTION TEST

NO	TEST ITEM	SPECIFICATION	TEST CONDITION	RESULT
1	CURRENT TOLERANCE	±5%	I/P: 230 VAC I/P:115VAC O/P:FULL LOAD Ta:25°C	1.4066A/230VAC@CV MAX-2V 1.4053A /230VAC@CV MIN 1.4066A/115VAC@CV MAX-2V 1.4054A/115VAC@CV MIN +0.471%
2	CONSTANT CURRENT REGION	CH1: 89V~ 179V	I/P: 230 VAC O/P:FULL LOAD Ta:25°C	46V~ 178V /230VAC
3	OPEN CIRCUIT VOLTAGE (max.)	182V	I/P: 230 VAC O/P:NO LOAD Ta:25°C	179.5V
4	CURRENT ADJ. RANGE	CH1:700mA~ 1400mA	I/P: 230 VAC I/P:115VAC O/P:CV MIN & CV MAX-2V Ta:25°C	1.625A~ 0.542A /230VAC@CV MAX-2V 1.623A~ 0.543A /230VAC@CV MIN 1.625A~ 0.542A /115VAC@CV MAX-2V 1.622A~0.543 A/115VAC@CV MIN
5	CURRENT RIPPLE	5.0% max. @rated current	I/P: 230 VAC O/P:FULL LOAD Ta:25°C	1.46%
6	SET UP TIME(Max)	230VAC/500 ms 115VAC/1000ms	I/P: 230 VAC I/P: 115 VAC O/P:FULL LOAD Ta:25°C	230VAC/ 328 ms 115 VAC/ 378ms
<p>INPUT=230VAC/50HZ @ FULL LOAD</p> <p>CH1 : AC Input Voltage CH2 : Output Voltage</p>		<p>INPUT=115VAC/60HZ @ FULL LOAD</p> <p>CH1 : AC Input Voltage CH2 : Output Voltage</p>		
7	DIMMING OPERATION (for B-Type)	<p>※3 in 1 dimming function</p> <p>※Output constant current level can be adjusted by applying one of the three methodologies between DIM+ and DIM-: 1 ~ 10VDC, or 10V PWM signal or resistance.</p> <p>※Direct connecting to LEDs is suggested. It is not suitable to be used with additional drivers.</p> <p>※Dimming source current from power supply: 100μ A (typ.)</p>		

© Applying additive 1 ~ 10VDC

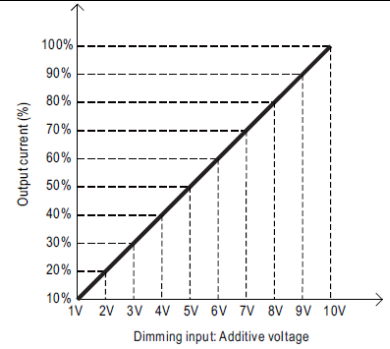
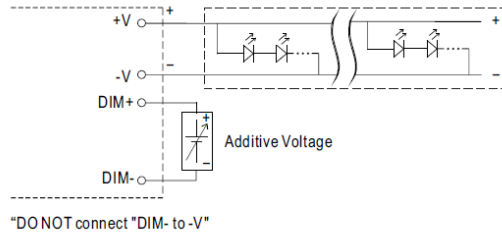

© Applying additive 10V PWM signal (frequency range 100Hz ~ 3KHz):

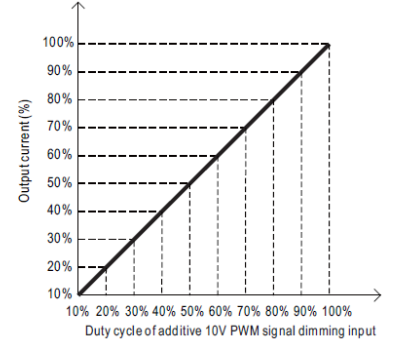
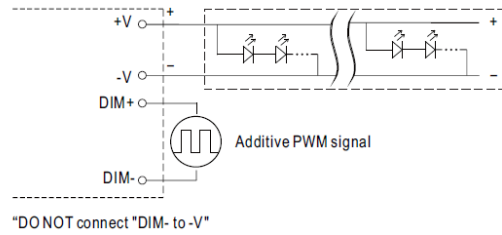

© Applying additive resistance:

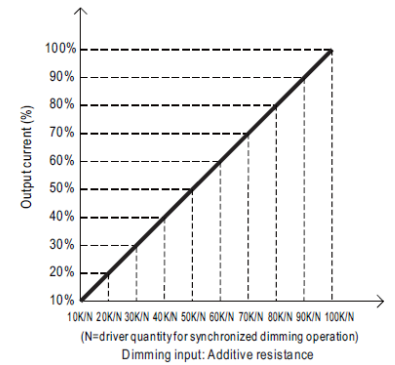
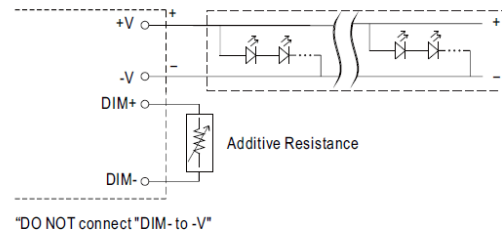

Note: In the case of turning the lighting fixture down to 0% brightness, please refer to the configuration as follow, or please contact MEAN WELL for other options.

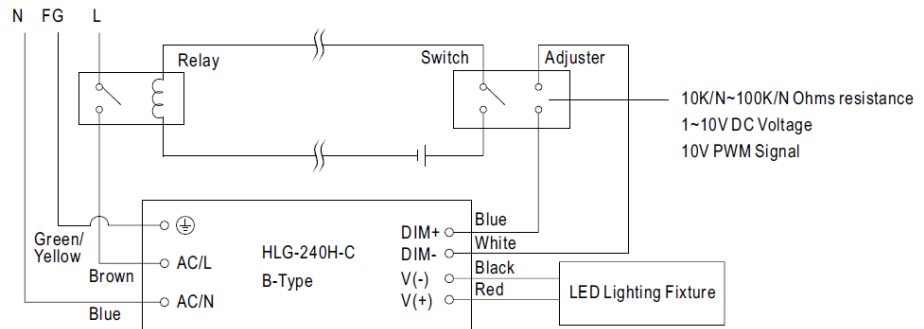

Using a switch and relay can turn ON/OFF the lighting fixture.

I/P : 230VAC

O/P : DIMMING TEST

TA : 25°C

R	10K	20K	30K	40K	50K	60K	70K	80K	90K	100K	OPEN
O/P CURRENT	0.143A	0.287A	0.433A	0.565A	0.720A	0.867A	1.013A	1.142A	1.300A	1.429A	1.474A
%	10.19%	20.52%	30.92%	40.38%	51.39%	61.96%	72.37%	81.54%	92.86%	102.07%	105.29%
V	1V	2V	3V	4V	5V	6V	7V	8V	9V	10V	OPEN

		<table border="1"> <tr> <td>O/P CURRENT</td> <td>0.142A</td> <td>0.286A</td> <td>0.436A</td> <td>0.583A</td> <td>0.726A</td> <td>0.868A</td> <td>1.018A</td> <td>1.159A</td> <td>1.309A</td> <td>1.448A</td> <td>1.474A</td> </tr> <tr> <td>%</td> <td>10.14%</td> <td>20.43%</td> <td>31.11%</td> <td>41.64%</td> <td>51.86%</td> <td>61.98%</td> <td>72.69%</td> <td>82.79%</td> <td>93.47%</td> <td>103.43%</td> <td>105.29%</td> </tr> <tr> <td>PWM (100HZ)</td> <td>10%</td> <td>20%</td> <td>30%</td> <td>40%</td> <td>50%</td> <td>60%</td> <td>70%</td> <td>80%</td> <td>90%</td> <td>100%</td> <td>OPEN</td> </tr> <tr> <td>O/P CURRENT</td> <td>0.132A</td> <td>0.287A</td> <td>0.438A</td> <td>0.589A</td> <td>0.738A</td> <td>0.886A</td> <td>1.033A</td> <td>1.181A</td> <td>1.328A</td> <td>1.472A</td> <td>1.474A</td> </tr> <tr> <td>%</td> <td>9.45%</td> <td>20.49%</td> <td>31.29%</td> <td>42.06%</td> <td>52.74%</td> <td>63.29%</td> <td>73.81%</td> <td>84.34%</td> <td>94.86%</td> <td>105.17%</td> <td>105.29%</td> </tr> </table>	O/P CURRENT	0.142A	0.286A	0.436A	0.583A	0.726A	0.868A	1.018A	1.159A	1.309A	1.448A	1.474A	%	10.14%	20.43%	31.11%	41.64%	51.86%	61.98%	72.69%	82.79%	93.47%	103.43%	105.29%	PWM (100HZ)	10%	20%	30%	40%	50%	60%	70%	80%	90%	100%	OPEN	O/P CURRENT	0.132A	0.287A	0.438A	0.589A	0.738A	0.886A	1.033A	1.181A	1.328A	1.472A	1.474A	%	9.45%	20.49%	31.29%	42.06%	52.74%	63.29%	73.81%	84.34%	94.86%	105.17%	105.29%
O/P CURRENT	0.142A	0.286A	0.436A	0.583A	0.726A	0.868A	1.018A	1.159A	1.309A	1.448A	1.474A																																																			
%	10.14%	20.43%	31.11%	41.64%	51.86%	61.98%	72.69%	82.79%	93.47%	103.43%	105.29%																																																			
PWM (100HZ)	10%	20%	30%	40%	50%	60%	70%	80%	90%	100%	OPEN																																																			
O/P CURRENT	0.132A	0.287A	0.438A	0.589A	0.738A	0.886A	1.033A	1.181A	1.328A	1.472A	1.474A																																																			
%	9.45%	20.49%	31.29%	42.06%	52.74%	63.29%	73.81%	84.34%	94.86%	105.17%	105.29%																																																			
		TEST RESULT : OK																																																												
8	<b>DIMMING OPERATION (for Dxx-Type by User definition)</b>	<p>※<b>Smart timer dimming function (for Dxx-Type by User definition)</b></p> <p>MEAN WELL Smart timer dimming primarily provides the adaptive proportion dimming profile for the output constant current level to perform up to 14 consecutive hours. 3 dimming profiles hereunder are defined accounting for the most frequently seen applications. If other options may be needed, please contact MEAN WELL for details.</p> <p>Ex : Ⓒ D01-Type: the profile recommended for residential lighting</p> <p>Set up for D01-Type in Smart timer dimming software program:</p> <table border="1"> <thead> <tr> <th></th> <th>T1</th> <th>T2</th> <th>T3</th> <th>T4</th> </tr> </thead> <tbody> <tr> <td>TIME**</td> <td>06:00</td> <td>07:00</td> <td>11:00</td> <td>--</td> </tr> <tr> <td>LEVEL**</td> <td>100%</td> <td>70%</td> <td>50%</td> <td>70%</td> </tr> </tbody> </table> <p>Ex : Ⓒ D02-Type: the profile recommended for street lighting</p> <p>Set up for D02-Type in Smart timer dimming software program:</p> <table border="1"> <thead> <tr> <th></th> <th>T1</th> <th>T2</th> <th>T3</th> <th>T4</th> <th>T5</th> </tr> </thead> <tbody> <tr> <td>TIME**</td> <td>01:00</td> <td>03:00</td> <td>8:00</td> <td>11:00</td> <td>--</td> </tr> <tr> <td>LEVEL**</td> <td>50%</td> <td>80%</td> <td>100%</td> <td>60%</td> <td>80%</td> </tr> </tbody> </table> <p>Ex : Ⓒ D03-Type: the profile recommended for tunnel lighting</p> <p>Set up for D03-Type in Smart timer dimming software program:</p> <table border="1"> <thead> <tr> <th></th> <th>T1</th> <th>T2</th> <th>T3</th> </tr> </thead> <tbody> <tr> <td>TIME**</td> <td>01:30</td> <td>11:00</td> <td>--</td> </tr> <tr> <td>LEVEL**</td> <td>70%</td> <td>100%</td> <td>70%</td> </tr> </tbody> </table> <p>I/P : 230VAC  O/P : DIMMING TEST  TA : 25°C  TEST RESULT : OK</p>		T1	T2	T3	T4	TIME**	06:00	07:00	11:00	--	LEVEL**	100%	70%	50%	70%		T1	T2	T3	T4	T5	TIME**	01:00	03:00	8:00	11:00	--	LEVEL**	50%	80%	100%	60%	80%		T1	T2	T3	TIME**	01:30	11:00	--	LEVEL**	70%	100%	70%															
	T1	T2	T3	T4																																																										
TIME**	06:00	07:00	11:00	--																																																										
LEVEL**	100%	70%	50%	70%																																																										
	T1	T2	T3	T4	T5																																																									
TIME**	01:00	03:00	8:00	11:00	--																																																									
LEVEL**	50%	80%	100%	60%	80%																																																									
	T1	T2	T3																																																											
TIME**	01:30	11:00	--																																																											
LEVEL**	70%	100%	70%																																																											

## INPUT FUNCTION TEST



# 250W Single Output LED Power Supply HLG-240H-Cseries

NO	TEST ITEM	SPECIFICATION	TEST CONDITION	RESULT																																												
1	INPUT VOLTAGE RANGE	90VAC~305 VAC	I/P:TESTING O/P:FULL LOAD Ta:25°C	70V~305V																																												
			I/P: (1)LOW-LINE-3V=87 V HIGH-LINE+10V=315 V O/P:FULL/MIN LOAD (PLEASE CHECK DERATING CURVE) ON: 30 Sec . OFF: 30 Sec 10MIN ( POWER ON/OFF NO DAMAGE ) (2) I/P:230Vac ON: 0.5 Sec . OFF: 0.5 Sec 20MIN	(1).TEST:OK (2).TEST :OK																																												
2	INPUT FREQUENCY RANGE	47HZ ~63 HZ NO DAMAGE	I/P: 110 VAC ~305VAC O/P:FULL~MIN LOAD Ta:25°C	OK																																												
3	INPUT CURRENT (TYP)	277VAC/ 1.1 A 230 VAC/ 1.3 A 115 VAC/ 2.5 A	I/P: 277VAC/230 VAC/115 VAC O/P:FULL LOAD Ta:25°C	I= 1.008A/277VAC I =1.178 A/ 230VAC I = 2.405A/ 115VAC																																												
4	POWER FACTOR(TYP)	0.95/230 VAC FULL LOAD 0.98/115 VAC FULL LOAD 0.92/277 VAC FULL LOAD	I/P: 230 VAC/115VAC/277VAC O/P:FULL LOAD Ta:25°C	PF= 0.9829/230V100%LOAD PF=0.9953/115V/100%LOAD PF=0.9486 /277V/100%LOAD																																												
<p>P.F vs LOAD</p> <table border="1"> <caption>P.F vs LOAD Data</caption> <thead> <tr> <th>Load (%)</th> <th>230V P.F</th> <th>115V P.F</th> <th>277V P.F</th> </tr> </thead> <tbody> <tr><td>10%</td><td>0.58</td><td>0.90</td><td>0.40</td></tr> <tr><td>20%</td><td>0.78</td><td>0.95</td><td>0.60</td></tr> <tr><td>30%</td><td>0.88</td><td>0.97</td><td>0.73</td></tr> <tr><td>40%</td><td>0.92</td><td>0.98</td><td>0.80</td></tr> <tr><td>50%</td><td>0.95</td><td>0.99</td><td>0.86</td></tr> <tr><td>60%</td><td>0.96</td><td>0.99</td><td>0.89</td></tr> <tr><td>70%</td><td>0.97</td><td>0.99</td><td>0.91</td></tr> <tr><td>80%</td><td>0.97</td><td>0.99</td><td>0.93</td></tr> <tr><td>90%</td><td>0.98</td><td>0.99</td><td>0.94</td></tr> <tr><td>100%</td><td>0.98</td><td>0.99</td><td>0.95</td></tr> </tbody> </table>					Load (%)	230V P.F	115V P.F	277V P.F	10%	0.58	0.90	0.40	20%	0.78	0.95	0.60	30%	0.88	0.97	0.73	40%	0.92	0.98	0.80	50%	0.95	0.99	0.86	60%	0.96	0.99	0.89	70%	0.97	0.99	0.91	80%	0.97	0.99	0.93	90%	0.98	0.99	0.94	100%	0.98	0.99	0.95
Load (%)	230V P.F	115V P.F	277V P.F																																													
10%	0.58	0.90	0.40																																													
20%	0.78	0.95	0.60																																													
30%	0.88	0.97	0.73																																													
40%	0.92	0.98	0.80																																													
50%	0.95	0.99	0.86																																													
60%	0.96	0.99	0.89																																													
70%	0.97	0.99	0.91																																													
80%	0.97	0.99	0.93																																													
90%	0.98	0.99	0.94																																													
100%	0.98	0.99	0.95																																													
5	EFFICIENCY (TYP)	94%	I/P: 230 VAC O/P:FULL LOAD Ta:25°C	94.2%																																												
			EFFICIENCY vs LOAD																																													

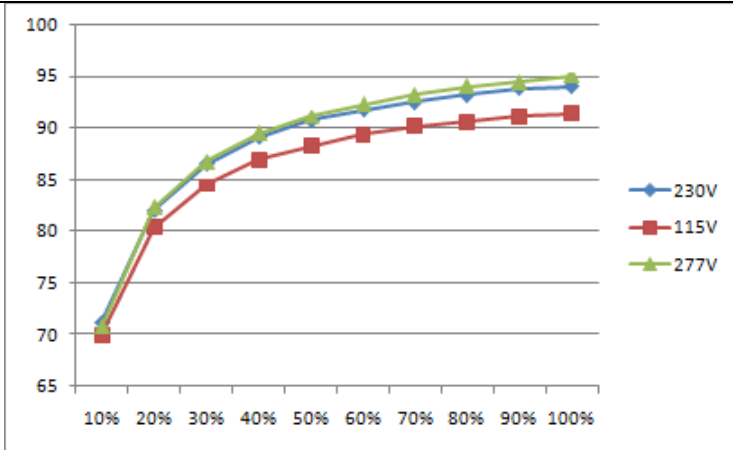

6	TOTAL HARMONIC DISTORTION	<p>Total harmonic distortion will be lower than 20% when output loading is 50% or higher at 230VAC / 115VAC</p> <p>Total harmonic distortion will be lower than 20% when output loading is 75% or higher at 277VAC</p>	<p>I/P : 230VAC I/P : 115VAC O/P : 50% LOAD Ta : 25°C</p>	<p>THD : 5.2524 % THD : 4.4490 %</p>
			<p>I/P : 277VAC O/P : 75% LOAD Ta : 25°C</p>	<p>THD : 6.172 %</p>

**THD&LOAD**

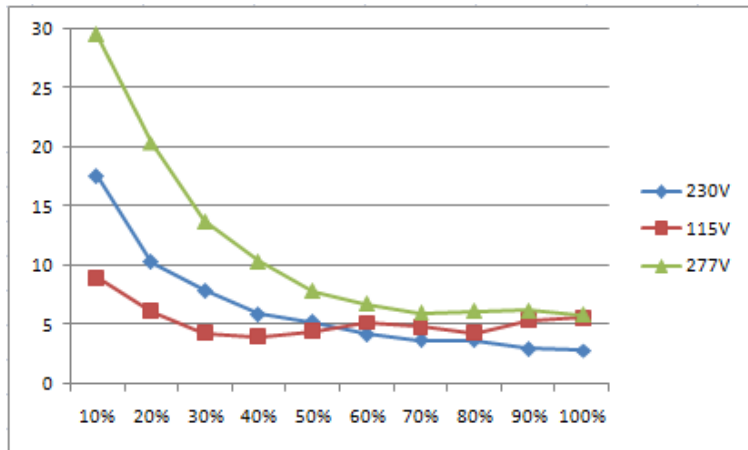

7	INRUSH CURRENT (TYP)	<p>230 V/ 75A COLD START</p> <p>(twidh= 700 us measured at 50% Ipeak) COLD START</p>	<p>I/P: 230 VAC O/P: FULL LOAD Ta:25°C</p>	<p>I=61.7 A/ 230VAC</p> <p>T50= 584 us</p>
---	----------------------	--	--	--

INPUT=230VAC/50HZ @ FULL LOAD  
CH2 : AC Input Voltage CH4 : Input current (1V=1A)

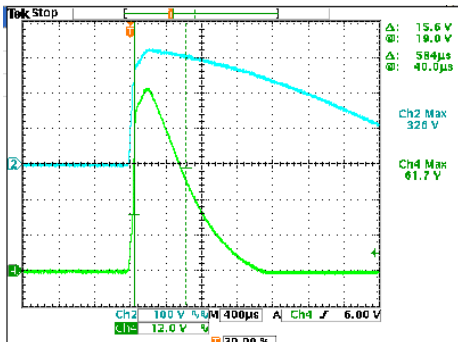

## PROTECTION FUNCTION TEST

NO	TEST ITEM	SPECIFICATION	TEST CONDITION	RESULT
1	OVER VOLTAGE PROTECTION	V1: 188V~ 206 V	I/P: 305VAC I/P: 230VAC I/P: 90VAC O/P:MIN LOAD Ta:25°C	193.89V/ 305VAC 193.64V/ 230VAC 194.59V/ 90VAC PROTECTION TYPE : Shut down and latch off o/p voltage, re-power on to recover
2	OVER TEMPERATURE PROTECTION	PROTECTION TYPE : Shut down o/p voltage, recovers automatically after temperature goes down	I/P: 305 VAC I/P: 90 VAC O/P:FULL LOAD	O.T.P. Active PROTECTION TYPE : Shut down o/p voltage, recovers automatically after temperature goes down
3	SHORT PROTECTION	SHORT EVERY OUTPUT 1 HOUR NO DAMAGE	I/P: 305VAC I/P: 90 VAC O/P: FULL LOAD Ta:25°C	NO DAMAGE PROTECTION TYPE : Constant current limiting, recovers automatically after fault condition is removed

## COMPONENT STRESS TEST

NO	TEST ITEM	SPECIFICATION	TEST CONDITION	RESULT
1	P.F.C Transistor ( D to S) or (C to E) Peak Voltage	Q1Rated 600V/19A	I/P:High-Line +3V =308V AC ON/OFF VDS: O/P: (1)Full Load (2)Output Short (3)FULL LOAD CONTINUE  I/P:Low-Line -3V = 107V AC ON/OFF VDS O/P: (1)Full Load (2)Output Short (3)FULL LOAD CONTINUE Ta:25°C	VDS: (1)512V (2)458V (3)504V  VDS: (1)522V (2)460V (3)514V
2	PWM Transistor ( D to S) or (C to E) Peak Voltage	Q3 Rated 20A/600V	I/P:High-Line +3V =308V AC ON/OFF VDS: O/P: (1)Full Load (2)Output Short (3)FULL LOAD CONTINUE  I/P:Low-Line -3V = 107V AC ON/OFF VDS O/P: (1)Full Load (2)Output Short (3)FULL LOAD CONTINUE Ta:25°C	VDS: (1)474V (2)494V (3)466V  VDS: (1)468V (2)460V (3)458V

3	Diode Peak Voltage	D102 Rated 10A/400V  D103 Rated 10A/400V	I/P:High-Line +3V = 308 V AC ON/OFF VDS: O/P: (1)Full Load (2)Output Short (3)FULL LOAD CONTINUE Ta:25°C	D102: VDS: (1)386V (2)32V (3)384V  D103: VDS: (1)390V (2)35.2V (3)388V
4	Input Capacitor Voltage	C5 Rated: 150u/450V SURGE POWER :495V	I/P:High-Line +3V =308 V O/P: (1)Full Load input on/off (2) Min load input on /Off (3)Full Load /Min load Change Ta:25°C	(1)452V (2)454V (3)446 V
5	Control IC Voltage Test	PWM IC U70 Rated 8.85V~16V	I/P:High-Line +3V =308 V AC ON/OFF O/P(1)FULL LOAD (2) Output Short (3)O.L.P (4)O.V.P. (5)NO (LOW LINE) Ta:25°C	(1) 15.5V (2) 14.8V (3) 14.8V (4) 15.4V (5) 14.6V

## SAFETY & EMC TEST

### SAFETY TEST

NO	TEST ITEM	SPECIFICATION	TEST CONDITION	RESULT
1	WITHSTAND VOLTAGE	IEC60950-1 I/P-O/P: 3.75KVAC/min I/P-FG: 2 KVAC/min<4.5mA O/P-FG:1.5KVAC/min	I/P-O/P: 4.125 KVAC/min I/P-FG: 2.4 KVAC/min O/P-FG: 1.8 KVAC/min Ta:25°C	I/P-O/P:3.97 mA I/P-FG:4.2 mA O/P-FG:3.33 mA NO DAMAGE
2	ISOLATION RESISTANCE	I/P-O/P:500VDC>100MΩ I/P-FG: 500VDC>100MΩ O/P-FG:500VDC>100MΩ	I/P-O/P: 500 VDC I/P-FG: 500 VDC O/P-FG: 500 VDC Ta:25°C	I/P-O/P: 28GΩ I/P-FG: 10.5G Ω O/P-FG:8.85 G Ω NO DAMAGE
3	GROUNDING CONTINUITY	IEC60950-1 FG(PE) TO CHASSIS OR TRACE < 100 mΩ	40A / 2min Ta:25°C	30mΩ
4	LEAKAGE CURRENT	IEC60950-1 < 0.75mA / 277VAC	I/P: 277 VAC O/P:Min LOAD Ta:25°C	L-FG: 0.34mA N-FG:0.34 mA L,N -V(+):0.26mA L,N-V(-):0.26mA

### E.M.C TEST

NO	TEST ITEM	SPECIFICATION	TEST CONDITION	RESULT
1	HARMONIC	EN61000-3-2 CLASS A CLASS C	I/P: 230VAC/50HZ O/P: FULL LOAD Ta:25°C	PASS
2	CONDUCTION	EN55015 CLASS B	I/P: 230 VAC (50HZ) O/P:FULL/50% LOAD Ta:25°C	PASS Test by certified Lab
3	RADIATION	EN55015 CLASS B	I/P: 230 VAC (50HZ) O/P:FULL LOAD Ta:25°C	PASS Test by certified Lab



4	E.S.D	EN61000-4-2 LIGHT INDUSTRY AIR:8KV / Contact:4KV	I/P: 230 VAC/50HZ O/P:FULL LOAD Ta:25°C	CRITERIA A
5	E.F.T	EN61000-4-4 INDUSTRY INPUT: 2KV	I/P: 230 VAC/50HZ O/P:FULL LOAD Ta:25°C	CRITERIA A
6	SURGE	IEC61000-4-5 INDUSTRY L-N :2KV L,N-PE:4KV	I/P: 230 VAC/50HZ O/P:FULL LOAD Ta:25°C	CRITERIA A
7	Test by certified Lab & Test Report Prepare. Any contradictions of the test results, please refer to the latest EMC test report.			

## RELIABILITY TEST

### ENVIRONMENT TEST

NO	TEST ITEM	SPECIFICATION	TEST CONDITION	RESULT																																																																																
1	TEMPERATURE RISE TEST	MODEL : HLG-240H-C1400 1. ROOM AMBIENT BURN-IN : 3 HRS I/P : 230VAC O/P : FULL LOAD Ta= 29.2 °C 2. HIGH AMBIENT BURN-IN : 6 HRS I/P : 230VAC O/P : FULL LOAD Ta= 55.7 °C																																																																																		
				<table border="1"> <thead> <tr> <th>NO</th> <th>Position</th> <th>ROOM AMBIENT</th> <th>HIGH AMBIENT</th> </tr> </thead> <tbody> <tr><td>1</td><td>BD1</td><td>71.7°C</td><td>94.1°C</td></tr> <tr><td>2</td><td>C14</td><td>69.7°C</td><td>92.2°C</td></tr> <tr><td>3</td><td>LF2</td><td>67.8°C</td><td>89.8°C</td></tr> <tr><td>4</td><td>Q1</td><td>71.3°C</td><td>94.1°C</td></tr> <tr><td>5</td><td>D3</td><td>71.0°C</td><td>93.9°C</td></tr> <tr><td>6</td><td>L2</td><td>70.1°C</td><td>92.4°C</td></tr> <tr><td>7</td><td>L1</td><td>71.9°C</td><td>94.1°C</td></tr> <tr><td>8</td><td>D2</td><td>71.0°C</td><td>93.5°C</td></tr> <tr><td>9</td><td>TSW1</td><td>68.6°C</td><td>90.9°C</td></tr> <tr><td>10</td><td>Q3</td><td>70.1°C</td><td>92.4°C</td></tr> <tr><td>11</td><td>C5</td><td>67.3°C</td><td>89.8°C</td></tr> <tr><td>12</td><td>C35</td><td>70.0°C</td><td>92.6°C</td></tr> <tr><td>13</td><td>C37</td><td>70.0°C</td><td>92.6°C</td></tr> <tr><td>14</td><td>D102</td><td>72.2°C</td><td>94.4°C</td></tr> <tr><td>15</td><td>T1</td><td>90.3°C</td><td>111.5°C</td></tr> <tr><td>16</td><td>C201</td><td>70.9°C</td><td>93.2°C</td></tr> <tr><td>17</td><td>C102</td><td>69.4°C</td><td>91.8°C</td></tr> <tr><td>18</td><td>U1</td><td>69.3°C</td><td>91.6°C</td></tr> <tr><td>19</td><td>U201</td><td>74.3°C</td><td>96.8°C</td></tr> </tbody> </table>	NO	Position	ROOM AMBIENT	HIGH AMBIENT	1	BD1	71.7°C	94.1°C	2	C14	69.7°C	92.2°C	3	LF2	67.8°C	89.8°C	4	Q1	71.3°C	94.1°C	5	D3	71.0°C	93.9°C	6	L2	70.1°C	92.4°C	7	L1	71.9°C	94.1°C	8	D2	71.0°C	93.5°C	9	TSW1	68.6°C	90.9°C	10	Q3	70.1°C	92.4°C	11	C5	67.3°C	89.8°C	12	C35	70.0°C	92.6°C	13	C37	70.0°C	92.6°C	14	D102	72.2°C	94.4°C	15	T1	90.3°C	111.5°C	16	C201	70.9°C	93.2°C	17	C102	69.4°C	91.8°C	18	U1	69.3°C	91.6°C	19	U201	74.3°C	96.8°C
NO	Position	ROOM AMBIENT	HIGH AMBIENT																																																																																	
1	BD1	71.7°C	94.1°C																																																																																	
2	C14	69.7°C	92.2°C																																																																																	
3	LF2	67.8°C	89.8°C																																																																																	
4	Q1	71.3°C	94.1°C																																																																																	
5	D3	71.0°C	93.9°C																																																																																	
6	L2	70.1°C	92.4°C																																																																																	
7	L1	71.9°C	94.1°C																																																																																	
8	D2	71.0°C	93.5°C																																																																																	
9	TSW1	68.6°C	90.9°C																																																																																	
10	Q3	70.1°C	92.4°C																																																																																	
11	C5	67.3°C	89.8°C																																																																																	
12	C35	70.0°C	92.6°C																																																																																	
13	C37	70.0°C	92.6°C																																																																																	
14	D102	72.2°C	94.4°C																																																																																	
15	T1	90.3°C	111.5°C																																																																																	
16	C201	70.9°C	93.2°C																																																																																	
17	C102	69.4°C	91.8°C																																																																																	
18	U1	69.3°C	91.6°C																																																																																	
19	U201	74.3°C	96.8°C																																																																																	
2	LOW TEMPERATURE TURN ON TEST	TURN ON AFTER 2 HOUR	I/P : 305VAC/110VAC O/P : 100 % LOAD Ta= -40°C	TEST : OK																																																																																



# 250W Single Output LED Power Supply

# HLG-240H-Cseries

3	HIGH HUMIDITY HIGH TEMPERATURE HIGH VOLTAGE TURN ON TEST	AFTER 12 HOURS IN CHAMBER ON CONTROL 60 °C NO DAMAGE	I/P : 305 VAC O/P : FULL LOAD Ta= 60 °C HUMIDITY= 95 %R.H	TEST : OK
4	TEMPERATURE COEFFICIENT	± 0.03 %/°C (0~60°C)	I/P : 230 VAC O/P : FULL LOAD	± 0.022 %/°C (0~60°C)
5	STORAGE TEMPERATURE TEST	1. Thermal shock Temperature : -45°C~ +90°C 2. Temperature change rate : 25°C / MIN 3. Dwell time low and high temperature : 30 MIN/EACH 4. Total test cycle : 5 CYCLE 5. Input/Output condition : STATIC		OK
6	THERMAL SHOCK TEST	1. Thermal shock Temperature : -45°C~ +65°C 2. Temperature change rate : 25°C / MIN 3. Dwell time low and high temperature : 30 MIN/EACH 4. Total test cycle : 10 CYCLE 5. Input/Output condition : 230VAC/Full Load AC ON/OFF TEST turn on 58sec ; turn off 2sec		OK
7	VIBRATION TEST	1 Carton & 1 Set (1) Waveform : Sine Wave (2) Frequency : 10~500Hz (3) Sweep Time : 12min/sweep cycle (4) Acceleration : 5G (5) Test Time : 72min in each axis (X.Y.Z) (6) Ta : 25°C		TEST : OK
8	CAPACITOR LIFE CYCLE	HLG-240H-C1400 :SUPPOSE C102 IS THE MOST CRITICAL COMPONENT (2) I/P : 230VAC O/P : FULL LOAD Tc= 75 °C LIFE TIME (3) I/P : 230VAC O/P : 75% LOAD Tc= 75 °C LIFE TIME (4) I/P : 230VAC O/P : 50% LOAD Tc= 75 °C LIFE TIME		(1) 129737 HRS (2) 93030 HRS (3) 97466 HRS
9	MTBF	Conducted by Parts Stress Analysis Prediction 180K hrs min. MIL-HDBK-217F (25°C)		
10	Ongoing Reliability Test	I/P : 230VAC O/P : FULL LOAD TA=50°C Demonstration Mean Time Between Failure : 62,000 hours		

TEST RESULT	TESTER	REVIEW	APPROVAL
PASS	DANIEL GAO	SANFORD SU	VINCENT TSENG

12.10.30 A50-F031