

RCP-1600 / RCB-1600 / RHP-1U User's Manual

0.Safety Guidelines.....	1
1.Introduction.....	1
1.1 Introduction.....	1
1.2 Features.....	1
1.3 Order Information.....	1
1.4 Main Specification.....	2
2.Mechanical Specification and Input/Out Terminals.....	4
2.1 Mechanism of Supply/Charger Unit.....	4
2.2 Mechanism of Whole Rack System.....	5
3.Functions.....	7
3.1 Input Voltage Range.....	7
3.2 Inrush Current Limiting.....	7
3.3 Rated Power.....	7
3.4 Power Factor Correction (PFC).....	7
3.5 Output Voltage/Current Adjustment.....	7
3.6 Fan Speed Control.....	9
3.7 Short-Circuit and Over-Current Protection.....	9
3.8 Over-Voltage Protection.....	9
3.9 Over-Temperature protection and Alarm.....	9
3.10 AC OK Signal.....	9
3.11 DC OK Signal.....	9
3.12 Fan-Lock Protection and Alarm Signal.....	9
3.13 Remote Control.....	9
3.14 Remote Sense.....	9
3.15 Hot-Swap Operation.....	10
3.16 Parallel Operation.....	10
3.17 Series Operation.....	11
3.18 Auxiliary Power.....	12
4.Communication Protocol	12
4.1 PMBus Communication Interface.....	12
4.2 CANBus Communication Interface.....	22
5.Notes on Operation.....	36
5.1 Installation Method.....	36
5.2 Derating.....	37
5.3 Warranty.....	37



RCP-1600,RCB-1600,RHP-1U User's Manual

0.Safety Guidelines

- ⊙ Risk of electrical shock and energy hazard, all failure should be examined by a qualified technician. Please do not remove the case from the supply/charger or rack shelf unit by yourself.
- ⊙ Please do not change any component on the unit or make any kind of modification on it.
- ⊙ Please do not install the unit in places with high moisture, high ambient temperature or under direct sunlight.
- ⊙ The input voltage range is 100- 240Vac (50/60Hz), please do not feed in voltage that is over or less than 10% of that range.
- ⊙ The safety protection level of this unit is class I. The " Frame Ground"(⊥) on the rack shelf unit must be well connected to PE (Protective Earth).

1.Introduction

1.1 Introduction

The RCP-1600 is a rack mountable power supply that provides energy source for telecom equipments, monitoring systems, servers, etc, installing into a 19" rack shelf is required for operation. The RCB-1600 is a rack mountable charger, used to charge batteries, installing into a 19" rack shelf is required for operation.

1.2 Features Description

- ⊙ 44 mm low profile, suitable for standard 1U rack applications
- ⊙ Universal AC input/Full range
- ⊙ Built-in active PFC function, PF>0.98
- ⊙ Protections: short circuit/overload/over voltage /over temperature
- ⊙ Active current sharing up to 8000W (5 units) in one 19" rack shelf; up to 3 rack shelves (15 units maximum) can be connected in parallel for RCP-1600
- ⊙ Remote control for each unit of RCP/RCB-1600 ◦
- ⊙ Built-in remote sense function for RCP-1600
- ⊙ Built-in battery temperature compensation function for RCB-1600
- ⊙ Output voltage programming
- ⊙ Output current programming
- ⊙ Hot Swap operation
- ⊙ AC OK and DC OK signal outputs
- ⊙ Forced air cooling by built-in DC fan with fan speed control function
- ⊙ 5V/0.3A and 12V/0.8A auxiliary output
- ⊙ Built-in ORing FETs ◦
- ⊙ PMBus serial data transmission function
- ⊙ 5 years warranty

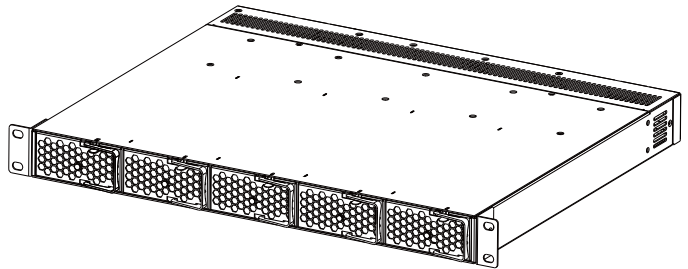

1.3 Order Information

1.3.1 Explanation for Encoding

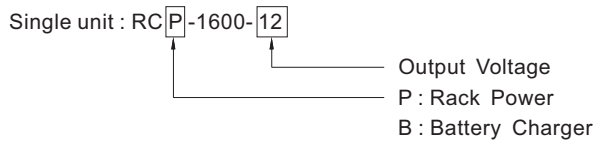

1.3.2 Marking

- ⊙ Please refer to the safety label on the top of the unit before use (Figure 1-1~1-5)
- ⊙ Supply/Charger unit

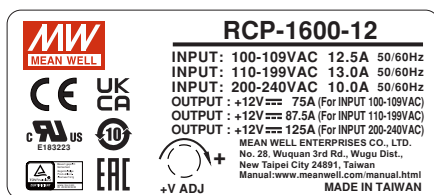

Figure1-1 safety label of RCP-1600

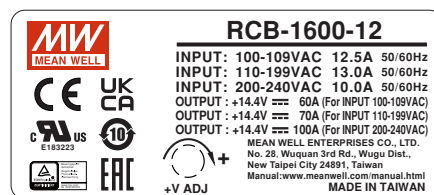

Figure1-2 safety label of RCB-1600

⊙Rack Shelf :

MW MEAN WELL **RHP-1UI-A**

Use only RCP-1600 or RCB-1600 series of identical model.

RCP-1600 series	RCB-1600 series
<input type="checkbox"/> 48V MODEL, Max. 5 modules provide INPUT: 100-109VAC 13.5A OUTPUT: +48V \approx 20.1A INPUT: 110-199VAC 14.0A OUTPUT: +48V \approx 23.5A INPUT: 200-240VAC 10.5A OUTPUT: +48V \approx 33.5A 50/60Hz	<input type="checkbox"/> 48V MODEL, Max. 5 modules provide INPUT: 100-109VAC 13.5A OUTPUT: +57.6V \approx 16.5A INPUT: 110-199VAC 14.0A OUTPUT: +57.6V \approx 19.5A INPUT: 200-240VAC 10.5A OUTPUT: +57.6V \approx 27.5A 50/60Hz
<input type="checkbox"/> 24V MODEL, Max. 5 modules provide INPUT: 100-109VAC 13.5A OUTPUT: +24V \approx 40.5A INPUT: 110-199VAC 14.0A OUTPUT: +24V \approx 47A INPUT: 200-240VAC 10.5A OUTPUT: +24V \approx 67A 50/60Hz	<input type="checkbox"/> 24V MODEL, Max. 5 modules provide INPUT: 100-109VAC 13.5A OUTPUT: +28.8V \approx 33A INPUT: 110-199VAC 14.0A OUTPUT: +28.8V \approx 38.5A INPUT: 200-240VAC 10.5A OUTPUT: +28.8V \approx 55A 50/60Hz
<input type="checkbox"/> 12V MODEL, Max. 5 modules provide INPUT: 100-109VAC 12.5A OUTPUT: +12V \approx 75A INPUT: 110-199VAC 13.0A OUTPUT: +12V \approx 87.5A INPUT: 200-240VAC 10.0A OUTPUT: +12V \approx 125A 50/60Hz	<input type="checkbox"/> 12V MODEL, Max. 5 modules provide INPUT: 100-109VAC 12.5A OUTPUT: +14.4V \approx 60A INPUT: 110-199VAC 13.0A OUTPUT: +14.4V \approx 70A INPUT: 200-240VAC 10.0A OUTPUT: +14.4V \approx 100A 50/60Hz

WARNING :

- Multiple power sources for configuration. Please disconnect all power sources and refer to the user manual before any service.
- The rating listed above is advised for one single module. Regarding the maximum output current when RHP-1U is fully populated, please refer to the user manual.

MEAN WELL ENTERPRISES CO., LTD.
No. 28, Wuqian 3rd Rd., Miqgu Dist., New Taipei City 24691, Taiwan
Manual: www.meanwell.com/manual.html

MADE IN TAIWAN

MW MEAN WELL **RHP-1UT-A**

Use only RCP-1600 or RCB-1600 series of identical model.

RCP-1600 series	RCB-1600 series
<input type="checkbox"/> 48V MODEL, Max. 5 modules provide INPUT: 100-109VAC 13.5A OUTPUT: +48V \approx 20.1A INPUT: 110-199VAC 14.0A OUTPUT: +48V \approx 23.5A INPUT: 200-240VAC 10.5A OUTPUT: +48V \approx 33.5A 50/60Hz	<input type="checkbox"/> 48V MODEL, Max. 5 modules provide INPUT: 100-109VAC 13.5A OUTPUT: +57.6V \approx 16.5A INPUT: 110-199VAC 14.0A OUTPUT: +57.6V \approx 19.5A INPUT: 200-240VAC 10.5A OUTPUT: +57.6V \approx 27.5A 50/60Hz
<input type="checkbox"/> 24V MODEL, Max. 5 modules provide INPUT: 100-109VAC 13.5A OUTPUT: +24V \approx 40.5A INPUT: 110-199VAC 14.0A OUTPUT: +24V \approx 47A INPUT: 200-240VAC 10.5A OUTPUT: +24V \approx 67A 50/60Hz	<input type="checkbox"/> 24V MODEL, Max. 5 modules provide INPUT: 100-109VAC 13.5A OUTPUT: +28.8V \approx 33A INPUT: 110-199VAC 14.0A OUTPUT: +28.8V \approx 38.5A INPUT: 200-240VAC 10.5A OUTPUT: +28.8V \approx 55A 50/60Hz
<input type="checkbox"/> 12V MODEL, Max. 5 modules provide INPUT: 100-109VAC 12.5A OUTPUT: +12V \approx 75A INPUT: 110-199VAC 13.0A OUTPUT: +12V \approx 87.5A INPUT: 200-240VAC 10.0A OUTPUT: +12V \approx 125A 50/60Hz	<input type="checkbox"/> 12V MODEL, Max. 5 modules provide INPUT: 100-109VAC 12.5A OUTPUT: +14.4V \approx 60A INPUT: 110-199VAC 13.0A OUTPUT: +14.4V \approx 70A INPUT: 200-240VAC 10.0A OUTPUT: +14.4V \approx 100A 50/60Hz

WARNING :

- Multiple power sources for configuration. Please disconnect all power sources and refer to the user manual before any service.
- The rating listed above is advised for one single module. Regarding the maximum output current when RHP-1U is fully populated, please refer to the user manual.

MEAN WELL ENTERPRISES CO., LTD.
No. 28, Wuqian 3rd Rd., Miqgu Dist., New Taipei City 24691, Taiwan
Manual: www.meanwell.com/manual.html

MADE IN TAIWAN

Figure 1-3: Safety label of RHP-1U

⊙Whole system :

MW MEAN WELL **RHP-8K1UI**

Use only RCP-1600 series of identical model.

<input type="checkbox"/> 48V MODEL, Max. 5 RCP-1600 modules provide INPUT: 100-109VAC 13.5A OUTPUT: +48V \approx 20.1A INPUT: 110-199VAC 14.0A OUTPUT: +48V \approx 23.5A INPUT: 200-240VAC 10.5A OUTPUT: +48V \approx 33.5A 50/60Hz
<input type="checkbox"/> 24V MODEL, Max. 5 RCP-1600 modules provide INPUT: 100-109VAC 13.5A OUTPUT: +24V \approx 40.5A INPUT: 110-199VAC 14.0A OUTPUT: +24V \approx 47A INPUT: 200-240VAC 10.5A OUTPUT: +24V \approx 67A 50/60Hz
<input type="checkbox"/> 12V MODEL, Max. 5 RCP-1600 modules provide INPUT: 100-109VAC 12.5A OUTPUT: +12V \approx 75A INPUT: 110-199VAC 13.0A OUTPUT: +12V \approx 87.5A INPUT: 200-240VAC 10.0A OUTPUT: +12V \approx 125A 50/60Hz

WARNING :

- Multiple power sources for configuration. Please disconnect all power sources and refer to the user manual before any service.
- The rating listed above is advised for one single module. Regarding the maximum output current when RHP-1U is fully populated, please refer to the user manual.

MEAN WELL ENTERPRISES CO., LTD.
No. 28, Wuqian 3rd Rd., Miqgu Dist., New Taipei City 24691, Taiwan
Manual: www.meanwell.com/manual.html

MADE IN TAIWAN

MW MEAN WELL **RHB-8K1UI-X**

Use only RCB-1600 series of identical model.

<input type="checkbox"/> .X=48, MODEL, Max. 5 RCB-1600 modules provide INPUT: 100-109VAC 13.5A OUTPUT: +57.6V \approx 16.5A INPUT: 110-199VAC 14.0A OUTPUT: +57.6V \approx 19.5A INPUT: 200-240VAC 10.5A OUTPUT: +57.6V \approx 27.5A 50/60Hz
<input type="checkbox"/> .X=24, MODEL, Max. 5 RCB-1600 modules provide INPUT: 100-109VAC 13.5A OUTPUT: +28.8V \approx 33A INPUT: 110-199VAC 14.0A OUTPUT: +28.8V \approx 38.5A INPUT: 200-240VAC 10.5A OUTPUT: +28.8V \approx 55A 50/60Hz
<input type="checkbox"/> .X=12, MODEL, Max. 5 RCB-1600 modules provide INPUT: 100-109VAC 12.5A OUTPUT: +14.4V \approx 60A INPUT: 110-199VAC 13.0A OUTPUT: +14.4V \approx 70A INPUT: 200-240VAC 10.0A OUTPUT: +14.4V \approx 100A 50/60Hz

WARNING :

- Multiple power sources for configuration. Please disconnect all power sources and refer to the user manual before any service.
- The rating listed above is advised for one single module. Regarding the maximum output current when RHP-1U is fully populated, please refer to the user manual.

MEAN WELL ENTERPRISES CO., LTD.
No. 28, Wuqian 3rd Rd., Miqgu Dist., New Taipei City 24691, Taiwan
Manual: www.meanwell.com/manual.html

MADE IN TAIWAN

Figure 1-4: Safety label of the whole RHP system

Figure 1-5: Safety label of the whole RHB system

1.4 Main Specification

⊙Supply/Charger unit

MODEL		RCP-1600-12	RCP-1600-24	RCP-1600-48	
OUTPUT	DC VOLTAGE	12V	24V	48V	
	RATED CURRENT	125A	67A	33.5A	
	CURRENT RANGE	0 ~ 125A	0 ~ 67A	0 ~ 33.5A	
	RATED POWER	1500W	1608W	1608W	
	RIPPLE & NOISE (max.) Note.2	150mVp-p	200mVp-p	300mVp-p	
	VOLTAGE ADJ. RANGE Note.6	11.5 ~ 15V	23.5 ~ 30V	47.5 ~ 58.8V	
	VOLTAGE TOLERANCE Note.4	\pm 1.0%	\pm 1.0%	\pm 1.0%	
	LINE REGULATION	\pm 0.5%	\pm 0.5%	\pm 0.5%	
	LOAD REGULATION	\pm 0.5%	\pm 0.5%	\pm 0.5%	
	SETUP, RISE TIME	1500ms, 60ms/230VAC at full load			
HOLD UP TIME (Typ.)	16ms / 230VAC at 75% load	10ms / 230VAC at full load			
INPUT	VOLTAGE RANGE Note.5	90 ~ 264VAC	250 ~ 370VDC		
	FREQUENCY RANGE	47 ~ 63Hz			
	POWER FACTOR (Typ.)	0.97/230VAC at full load			
	EFFICIENCY (Typ.)	88.5%	91%	93%	
	AC CURRENT (Typ.) Note.5	14A/115VAC	8A/230VAC	15A/115VAC	8.5A/230VAC
	INRUSH CURRENT (Typ.)	COLD START 35A/230VAC			
LEAKAGE CURRENT	<1.5mA / 230VAC				
PROTECTION	OVERLOAD	105 ~ 115% rated current			
	OVER VOLTAGE	Protection type : Constant current limiting, shut down O/P voltage after 5 sec. After O/P voltage falls, re-power on to recover			
	OVER TEMPERATURE	15.75 ~ 18.75V	31.5 ~ 37.5V	63 ~ 75V	
		Protection type : Shut down o/p voltage, re-power on to recover			
		Shut down o/p voltage, recovers automatically after temperature goes down			

MODEL		RCB-1600-12	RCB-1600-24	RCB-1600-48
OUTPUT	BOOST CHARGE VOLTAGE(Vboost)(default)	14.4V	28.8V	57.6V
	FLOAT CHARGE VOLTAGE(Vfloat)(default)	13.8V	27.6V	55.2V
	CURRENT RANGE	0 ~ 100A	0 ~ 55A	0 ~ 27.5A
	CONSTANT CURRENT(CC)(default)	100A	55A	27.5A
	RATED POWER	1440W	1584W	1584W
	VOLTAGE ADJ. RANGE	By built-in potentiometer, SVR		
		11.5 ~ 15V	23.5 ~ 30V	47.5 ~ 58.8V
RECOMMENDED BATTERY CAPACITY(AMP HOURS)	330 ~ 1000Ah	180 ~ 550Ah	90 ~ 270Ah	
LEAKAGE CURRENT FROM BATTERY (Typ.)	<1mA			
INPUT	VOLTAGE RANGE <small>Note.5</small>	90 ~ 264VAC 250 ~ 370VDC		
	FREQUENCY RANGE	47 ~ 63Hz		
	POWER FACTOR (Typ.)	0.97/230VAC at full load		
	EFFICIENCY (Typ.)	90.5%	92%	93%
	AC CURRENT (Typ.) <small>Note.5</small>	14A/115VAC 8A/230VAC		15A/115VAC 8.5A/230VAC
	INRUSH CURRENT (Typ.)	COLD START 35A/230VAC		
	LEAKAGE CURRENT	<1.5mA / 230VAC		
PROTECTION	OVER VOLTAGE	15.75 ~ 18.75V	31.5 ~ 37.5V	63 ~ 75V
		Protection type : Shut down o/p voltage, re-power on to recover		
	OVER TEMPERATURE	Shut down o/p voltage, recovers automatically after temperature goes down		

◎ Rack system

MODEL		RHP-8K1U□-12	RHP-8K1U□-24	RHP-8K1U□-48	
OUTPUT	RECTIFIER	RCP-1600-12	RCP-1600-24	RCP-1600-48	
	RACK SHELF	RHP-1UI-A or RHP-1UT-A			
	OUTPUT VOLTAGE	12V	24V	48V	
	MAX. OUTPUT CURRENT	625A	335A	167.5A	
	MAX. OUTPUT POWER <small>Note.5</small>	7500W	8040W	8040W	
INPUT	VOLTAGE RANGE <small>Note.6</small>	90 ~ 264VAC 127 ~ 370VDC			
	FREQUENCY RANGE	47 ~ 63Hz			
	AC CURRENT (Typ.) per RECTIFIER	14A/115VAC 8A/230VAC		15A/115VAC 8.5A/230VAC	
	LEAKAGE CURRENT per RECTIFIER <small>Note.8</small>	<1.5mA / 230VAC			
FUNCTION	OUTPUT VOLTAGE PROGRAMMABLE(PV)	Adjustment of output voltage is allowable to 40 ~ 125% of nominal output voltage(60~125% for 12V). Please refer to the Function Manual.			
	CONSTANT CURRENT LEVEL PROGRAMMABLE(PC)	Adjustment of constant current level is allowable to 20 ~ 100% of rated current. Please refer to the Function Manual.			
	REMOTE ON-OFF CONTROL	By electrical signal or dry contact ON:short OFF:open			
	REMOTE SENSE	Compensate voltage drop on the load wiring up to 0.5V			
	AUXILIARY POWER	5V @ 0.3A, 12V @ 0.8A			
	ALARM SIGNAL	Isolated TTL signal output for T-Alarm, AC-OK and DC-OK			
ENVIRONMENT	WORKING TEMP.	-30 ~ +70°C (Refer to "Derating Curve")			
	WORKING HUMIDITY	20 ~ 90% RH non-condensing			
	STORAGE TEMP., HUMIDITY	-40 ~ +85°C, 10 ~ 95% RH non-condensing			
	TEMP. COEFFICIENT	±0.03%/°C (0 ~ 50°C)			
	VIBRATION	10 ~ 500Hz, 2G 10min./1cycle, 60min. each along X, Y, Z axes			
SAFETY & EMC (Note 4)	SAFETY STANDARDS	UL62368-1, CAN/CSA C22.2 No. 62368-1, TUV BS EN/EN62368-1, EAC TP TC 004 approved			
	WITHSTAND VOLTAGE	I/P-O/P:3KVAC I/P-FG:2KVAC O/P-FG:1.5KVAC (0.5KVAC for 12V)			
	ISOLATION RESISTANCE	I/P-O/P, I/P-FG, O/P-FG:100M Ohms / 500VDC / 25°C / 70% RH			
	EMC EMISSION	Parameter	Standard	Test Level / Note	
		Conducted	BS EN/EN55032 (CISPR32)	Class B	
		Radiated	BS EN/EN55032 (CISPR32)	Class A	
		Harmonic Current	BS EN/EN61000-3-2	Class A	
		Voltage Flicker	BS EN/EN61000-3-3	-----	
	EMC IMMUNITY	BS EN/EN55035, BS EN/EN61000-6-2			
		Parameter	Standard	Test Level / Note	
		ESD	BS EN/EN61000-4-2	Level 3, 8KV air ; Level 2, 4KV contact	
		Radiated	BS EN/EN61000-4-3	Level 3	
		EFT / Burst	BS EN/EN61000-4-4	Level 3	
Surge		BS EN/EN61000-4-5	Level 4, 2KV/Line-Line 4KV/Line-Earth		
Conducted		BS EN/EN61000-4-6	Level 3		
Magnetic Field		BS EN/EN61000-4-8	Level 4		
Voltage Dips and Interruptions	BS EN/EN61000-4-11	>95% dip 0.5 periods, 30% dip 25 periods, >95% interruptions 250 periods			

MODEL	RHP-8K1U□-12	RHP-8K1U□-24	RHP-8K1U□-48
OTHERS	DIMENSION	Rack 365*482.6*44(L*W*H, with mounting bracket) ; 365*440*44(L*W*H, without mounting bracket)	
	PACKING	5.5Kg; 3pcs/17.5Kg/2.11CUFT	
NOTE	<p>1. All parameters NOT specially mentioned are measured at 230VAC input, rated load and 25°C of ambient temperature.</p> <p>2. Ripple & noise are measured at 20MHz of bandwidth by using a 12" twisted pair-wire terminated with a 0.1uf & 47uf parallel capacitor. Under parallel operation of more than one rack connecting together, ripple of the output voltage may be higher than the SPEC at light load condition. It will go back to normal ripple level once the output load is more than 5%.</p> <p>3. Tolerance : includes set up tolerance, line regulation and load regulation.</p> <p>4. The power supply is considered a component which will be installed into a final equipment. All the EMC tests are been executed by mounting the unit on a 1000mm*1300mm metal plate with 1mm of thickness. The final equipment must be re-confirmed that it still meets EMC directives. For guidance on how to perform these EMC tests, please refer to "EMI testing of component power supplies." (as available on https://www.meanwell.com/Upload/PDF/EMI_statement_en.pdf)</p> <p>5. Output of all the RCP-1600 modules are connected in parallel in the rack.</p> <p>6. Derating may be needed under low input voltages. Please check the static characteristics for more details.</p> <p>7. Because of component tolerance, there is a possibility that some of units connected in parallel will reach an overcurrent limit then overloading the other units when operating at full load condition. If overload conditions happen in parallel usage, it is suggested that derate the total output current by 10%.</p> <p>8. The equivalent leakage current of the system is determined by the quantity of populated rectifiers.</p> <p>9. The ambient temperature derating of 3.5°C/1000m with fanless models and of 5°C/1000m with fan models for operating altitude higher than 2000m(6500ft).</p>		

MODEL	RHB-8K1U□-12	RHB-8K1U□-24	RHB-8K1U□-48	
OUTPUT	CHARGER	RCB-1600-12	RCB-1600-24	RCB-1600-48
	RACK SHELF	RHP-1UI-A or RHP-1UT-A		
	BOOST CHARGE VOLTAGE(Vboost)(default)	14.4V	28.8V	57.6V
	FLOAT CHARGE VOLTAGE(Vfloat)(default)	13.8V	27.6V	55.2V
	CURRENT RANGE	0 ~ 500A	0 ~ 275A	0 ~ 137.5A
INPUT	VOLTAGE RANGE <small>Note.2</small>	90 ~ 264VAC 127 ~ 370VDC		
	FREQUENCY RANGE	47 ~ 63Hz		
	AC CURRENT (Typ.) per CHARGER	14A/115VAC 8A/230VAC	15A/115VAC 8.5A/230VAC	15A/115VAC 8.5A/230VAC
	LEAKAGE CURRENT per CHARGER <small>Note.5</small>	<1.5mA / 230VAC		
FUNCTION	OUTPUT VOLTAGE PROGRAMMABLE(PV)	Adjustment of output voltage is allowable to 75 ~ 125% of nominal output voltage. Please refer to the Function Manual.		
	OUTPUT CURRENT PROGRAMMABLE(PC)	Adjustment of output current is allowable to 20 ~ 100% of rated current. Please refer to the Function Manual.		
	REMOTE ON-OFF CONTROL	By electrical signal or dry contact ON:short OFF:open		
	AUXILIARY POWER	5V @ 0.3A, 12V @ 0.8A		
	ALARM SIGNAL	The isolated TTL signal out, Please refer to Installation Manual		
	TEMPERATURE COMPENSATION	-3mV / °C / cell / (12V = 6 cells ; 24V = 12 cells ; 48V = 24 cells)		
ENVIRONMENT	WORKING TEMP.	-30 ~ +70°C (Refer to "Derating Curve")		
	WORKING HUMIDITY	20 ~ 90% RH non-condensing		
	STORAGE TEMP., HUMIDITY	-40 ~ +85°C, 10 ~ 95% RH non-condensing		
	TEMP. COEFFICIENT	±0.03%/°C (0 ~ 50°C)		
	VIBRATION	10 ~ 500Hz, 2G 10min./1cycle, 60min. each along X, Y, Z axes		
SAFETY & EMC <small>(Note 4)</small>	SAFETY STANDARDS	UL62368-1, TUV BS EN/EN62368-1, EAC TP TC 004 approved		
	WITHSTAND VOLTAGE	I/P-O/P:3KVAC I/P-FG:2KVAC O/P-FG:1.5KVAC (0.5KVAC for 12V)		
	ISOLATION RESISTANCE	I/P-O/P, I/P-FG, O/P-FG:100M Ohms / 500VDC / 25°C / 70% RH		
	EMC EMISSION	Compliance to BS EN/EN55032 (CISPR32) Conduction Class B, Radiation Class A ; BS EN/EN61000-3-2,-3, EAC TP TC 020		
	EMC IMMUNITY	Compliance to BS EN/EN61000-4-2,3,4,5,6,8,11, BS EN/EN61000-6-2 (EN50082-2), BS EN/EN55035, Heavy industry level, criteria A, EAC TP TC 020		
OTHERS	DIMENSION	Rack 365*482.6*44(L*W*H, with mounting bracket) ; 365*440*44(L*W*H, without mounting bracket)		
	PACKING	5.5Kg; 3pcs/17.5Kg/2.11CUFT		
NOTE	<p>1. All parameters NOT specially mentioned are measured at 230VAC input, rated load and 25°C of ambient temperature.</p> <p>2. Derating may be needed under low input voltages. Please check the static characteristics for more details.</p> <p>3. The power supply is considered a component which will be installed into a final equipment. All the EMC tests are been executed by mounting the unit on a 1000mm*1300mm metal plate with 1mm of thickness. The final equipment must be re-confirmed that it still meets EMC directives. For guidance on how to perform these EMC tests, please refer to "EMI testing of component power supplies." (as available on https://www.meanwell.com/Upload/PDF/EMI_statement_en.pdf)</p> <p>4. Output of all the RCB-1600 modules are connected in parallel in the rack.</p> <p>5. The equivalent leakage current of the system is determined by the quantity of populated chargers.</p> <p>6. The ambient temperature derating of 3.5°C/1000m with fanless models and of 5°C/1000m with fan models for operating altitude higher than 2000m(6500ft).</p>			

2. Mechanical Specification and Input/Output Terminals

2.1 Mechanism of Supply/Charger unit

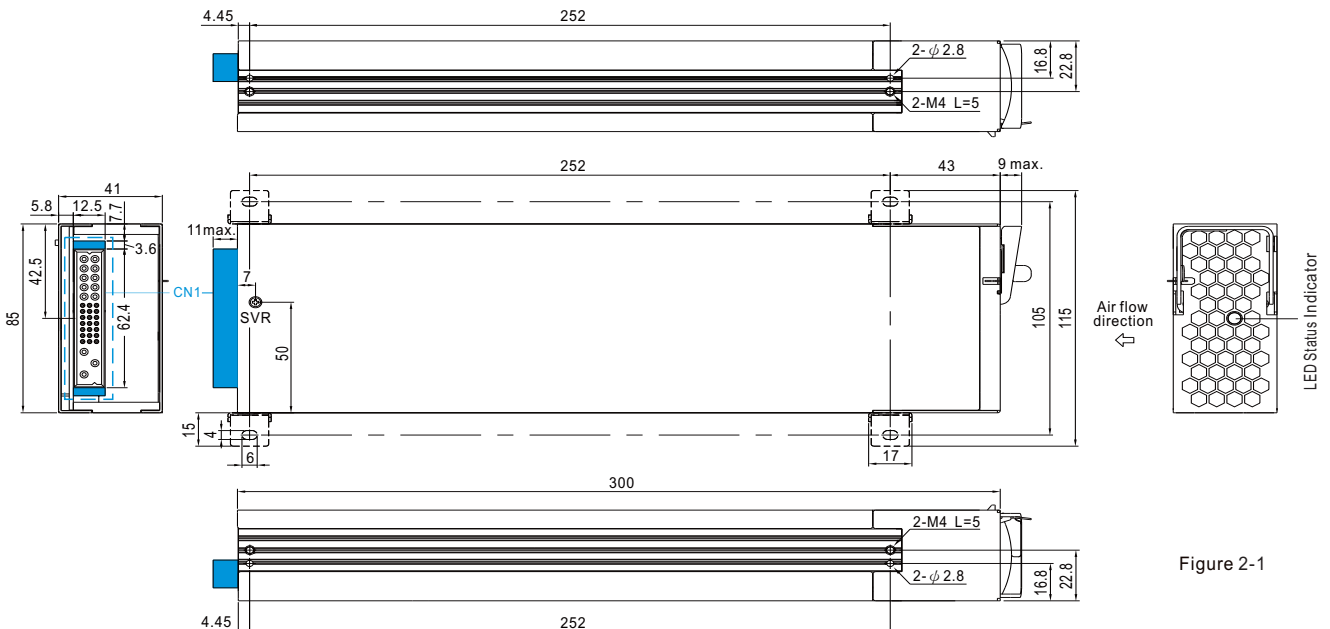

Figure 2-1

2.2 Mechanism of whole Rack system

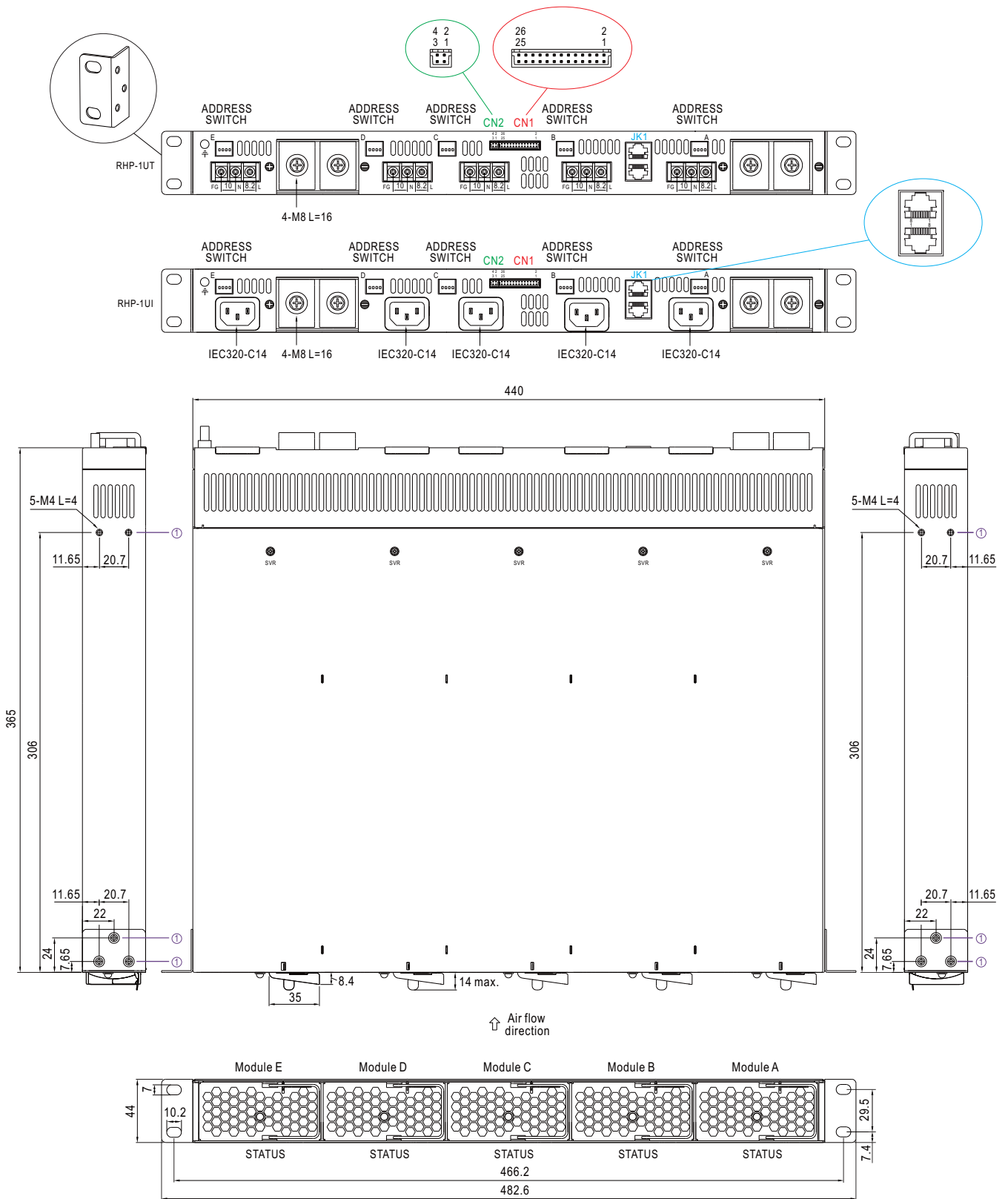
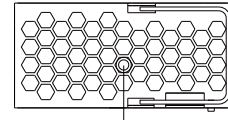

Figure 2-2

※ LED Status Indicators & Corresponding Signal at Function Pins

For power supply system

LED	Description
● Green	The power supply functions normally
● Red	The LED will present a constant red light when the abnormal status (OTP, OLP, fan fail) arises.
● Red(Flashing)	The LED will flash with the red light when the internal temperature reaches 60°C; under this condition, the unit still operates normally without entering OTP. (In the meantime, an alarm signal will be sent out through the PMBus interface.)



LED Status Indicator

Figure 2-3 RCP/RCB-1600 front panel

For charger system

LED	Description
● Green	Float(stage 3)
● Orange	Charging (stage 1 or stage 2)
● Red	The LED will present a constant red light when the abnormal status (OTP, OLP, fan fail and charging timeout) arises.
● Red(Flashing)	The LED will flash with the red light when the internal temperature reaches 60°C; under this condition, the unit still operates normally without entering OTP. (In the meantime, an alarm signal will be sent out through the PMBus interface.)

※ Connector Pin No. Assignment (CN1)

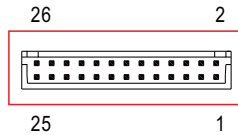

Pin No.	Function	Description
1,5,9,13,17	AC-OK	High (3.5 ~ 5.5V) : When the input voltage is $\geq 87V_{rms}$. Low (-0.5 ~ 0.5V) : When the input voltage is $\leq 75V_{rms}$. The maximum sourcing current is 10mA and only for output. (Note.2)
2,6,10,14,18	DC-OK	For power supply system High (3.5 ~ 5.5V) : When the $V_{out} \leq 77\% \pm 5\%$. Low (-0.5 ~ 0.5V) : When $V_{out} \geq 80\% \pm 5\%$. The maximum sourcing current is 10mA and only for output. (Note.2)
		For charger system High (3.5 ~ 5.5V) : When the $V_{out} \leq 8V/16V/32V \pm 1V$. Low (-0.5 ~ 0.5V) : When $V_{out} \geq 8V/16V/32V \pm 1V$. The maximum sourcing current is 10mA and only for output. (Note.2) DC OK is associated with battery low protection.
3,7,11,15,19	Remote ON-OFF	The unit can turn the output ON/OFF by electrical signal or dry contact between Remote ON-OFF and +5V-AUX. (Note.2) Short (4.5 ~ 5.5V) : Power ON ; Open (-0.5 ~ 0.5V) : Power OFF ; The maximum input voltage is 5.5V.
4,8,12,16,20	T-ALARM	High (3.5 ~ 5.5V) : When the internal temperature exceeds the limit of temperature alarm, or when fan fails. Low (-0.5 ~ 0.5V) : When the internal temperature is normal, and when fan normally works. The maximum sourcing current is 10mA and only for output(Note.2)
21	+5V-AUX	Auxiliary voltage output, 4.5~5.5V, referenced to GND-AUX (pin 22). The maximum load current is 0.3A. This output has the built-in "Oring diodes" and is not controlled by the remote ON/OFF control.
22	GND-AUX	Auxiliary voltage output GND. The signal return is isolated from the output terminals (+V & -V).
23	+12V-AUX	Auxiliary voltage output, 10.8~13.2V, referenced to GND-AUX (pin 22). The maximum load current is 0.8A. This output has the built-in "Oring diodes" and is not controlled by the remote ON/OFF control.
24	-V(Signal)	Negative output voltage. For local sense use only; It can't be connected directly to the load.
25	PC	Connection for output current programming. The current can be trimmed within its defined range. (Note.1)
26	PV	Connection for output voltage programming. The voltage can be trimmed within its defined range. (Note.1)

Note.1: Non-isolated signal, referenced to [-V(signal)].

Note.2: Isolated signal, referenced to GND-AUX.

※ Connector Pin No. Assignment (CN2)

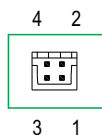

Note3: Wiring cable of CN2 varies in rack shelf with RCP-1600 or RCB-1600, please follow the discription below to select the correct cable for wiring, DO NOT make it misplaced!

For power supply system

1	+S	Positive sensing. The +S signal should be connected to the positive terminal of the load. The +S and -S leads should be twisted in pair to minimize noise pick-up effect. The maximum line drop compensation is 0.5V.
2	-S	Negative sensing. The -S signal should be connected to the negative terminal of the load. The -S and +S leads should be twisted in pair to minimize noise pick-up effect. The maximum line drop compensation is 0.5V.
3	+V(Signal)	Positive output voltage. For local sense use only, can't be connected directly to the load.
4	-V(Signal)	Negative output voltage. For local sense use only, can't be connected directly to the load.

◎ The RED wiring cable goes with the RCP-1600, used to compensate voltage drop on the load wiring.



⊙ For charger system

1	RTH+	Temperature sense associated with the temperature compensation function.
2	RTH-	
3,4	NC	Not use.

⊙ The Black wiring cable goes with the RCB-1600, used for battery temperature compensation.



※ Connector Pin No. Assignment(JK1) : RJ45 8 positions

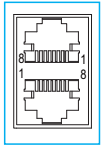

Pin No.	Function	Description
1,2	DA,DB	Differential digital signal for parallel control. (Note.1)
3	-V(signal)	Negative output voltage signal. It is for local sense and certain function reference; it cannot be connected directly to the load.
4	CONTROL	Remote ON-OFF control pin used in the PMBus interface. (Note.2)
5	NC	Retain for future use.
6	SDA	Serial Data used in the PMBus interface. (Note.2)
7	SCL	Serial Clock used in the PMBus interface. (Note.2)
8	GND-AUX	Auxiliary voltage output GND. The signal return is isolated from the output terminals (+V & -V).

Note.1: Non-isolated signal, referenced to [-V(signal)].

Note.2: Isolated signal, referenced to GND-AUX.

3.Functions

3.1 Input Voltage Range

- ⊙ The input voltage rang is AC90~264V or DC127~370V.
- ⊙ To insure proper operation, AC input should be within the pre-specified range. A wrong input will cause the supply/charger units operating improperly, losing PFC function or even damaging the units in worst scenario.
- ⊙ The efficiency will be lower and the output current will be automatically limited to a predetermined safe value if the units are applied with a lower input voltage. Please refer to 4.2 Derating for more information.

3.2 Inrush Current Limiting

- ⊙ Built-in inrush current limiting circuit.
- ⊙ If adding an external switch (relay/circuit break) at the input side is required, choose switches that are able to withstand inrush current of the units.
- ⊙ Since the inrush limiting circuit mainly consists of a thermistor and a relay, inrush current will be much higher than the specified value if input thermistor is not allowed sufficient time to cool down. After turning off the supplies/chargers, a 10 second cool down period is recommended before turning them on again.

3.3 Output Power

⊙ Front end unit

RCP-1600-12 : 1500W (12V / 125A)	RCB-1600-12 : 14.4V / 100A
RCP-1600-24 : 1608W (24V / 67A)	RCB-1600-24 : 28.8V / 55A
RCP-1600-48 : 1608W (48V / 33.5A)	RCB-1600-48 : 57.6V / 27.5A

⊙ Whole System

RKP-8K1U□-12 : 7500W (12V / 625A)	RHB-8K1U□-12 : 14.4V / 500A
RKP-8K1U□-24 : 8040W (24V / 335A)	RHB-8K1U□-24 : 28.8V / 275A
RKP-8K1U□-48 : 8040W (48V / 167.5A)	RHB-8K1U□-48 : 57.6V / 137.5A

3.4 Power Factor Correction(PFC)

- ⊙ Built-in active power factor correction (PFC) function, power factor (PF) will be 0.98 or better when the input voltage is in a range of 90 -230Vac and operated at full load condition. PF will be less than 0.98 if the output is not at full load or the input voltage is higher than 230Vac.

3.5 Output voltage/Current adjustment

3.5.1 Adjustment of single unit

Output voltage can be trimmed by adjusting SVR1 (which can be found under the small circular hole, located on the top of the unit). Please utilize an insulated cross-head screwdriver to make an adjustment.

3.5.2 Voltage adjustment of whole rack system by an external 0-5 Vdc source (output voltage trimming function)

- (1) Connect output of the external DC source to PV(PIN 26) and -V(PIN 24) on CN1, as shown in Figure3-1.
- (2) Relationship between the output voltage and the external DC source is shown in Figure3-2.
- (3) When increase the output to a higher voltage level, please reduce the load current accordingly. Output wattage of each unit should not exceed the rated value under any circumstance.

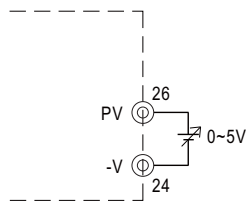

Figure 3-1 Connection of external DC voltage source

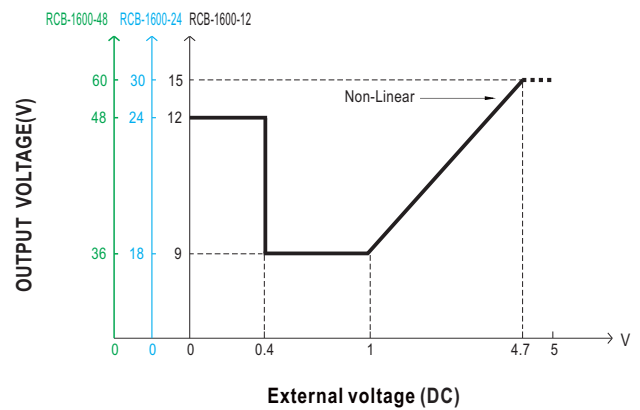
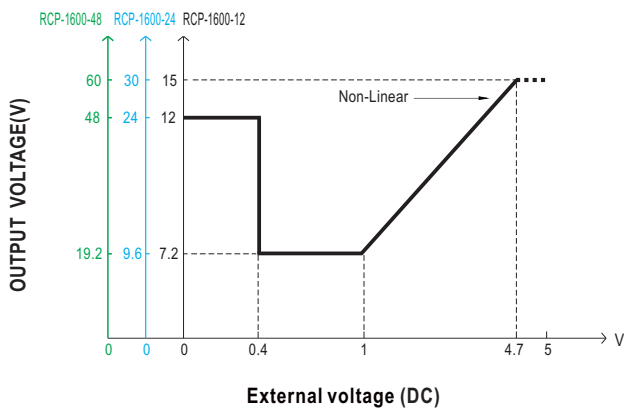
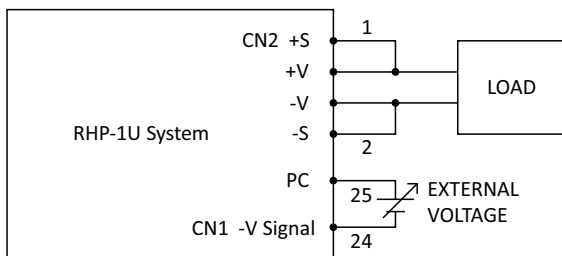

Figure 3-2

3.5.3 Output current adjustment (Output current trimming function)

※ Constant current level(RCP-1600)/output current (RCB-1600) can be adjusted within a range of 20-100% of the rated current via an external DC source, the wiring is show as below.



Connection between +S & +V, -S & -V on CN1 is required (RCP-1600system)

Relationship between the output current and the external DC source is shown as below.

© RCP-1600 System

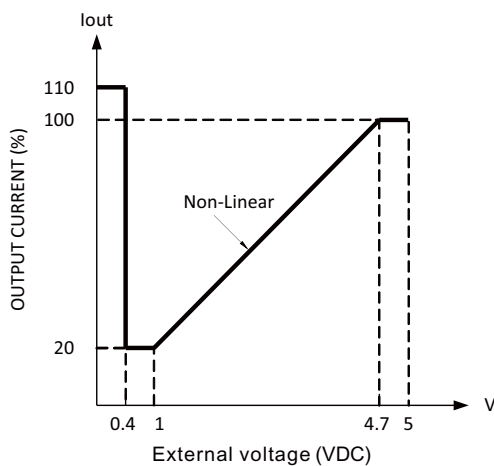

© RCB-1600 System

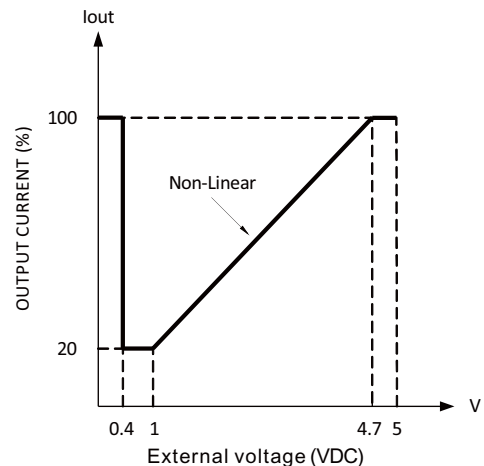

Note: The RCP-1600 will trigger OLP to shut down itself if the output stays on constant current level condition for more than 5 seconds.

3.6 Fan Speed Control

- ⊙ Built-in fan speed control circuit, the fan speed changes automatically depending on the internal temperature.

3.7 Short Circuit Protection & Over Current Protection (only for RCP-1600)

- ⊙ The protection activates when the output is short-circuited or the output current exceeds 110%±5% of the rated output current. Re-power on to recover when the short-circuit/overload condition is removed.

3.8 Over Voltage Protection (OVP)

- ⊙ Built-in over voltage protection circuit for every single units.
- ⊙ OVP triggering points vary in different output models. Please refer to the specification sheet for detailed information.
- ⊙ Once OVP is triggered, leave the units off for 10 seconds before recycling AC again.

3.9 Over Temperature Protection (OTP) and Alarm

- ⊙ Built-in 2 sets of thermal detection circuit, once the internal temperature exceeds a threshold value, the units will shut down automatically (the fans will still be operating to cool down the unit). Please switch off the AC input, remove all possible causes and then leave the units cooling down to a normal working temperature (approximate 10 minutes – 1 hour) before repower on again.
- ⊙ When the internal temperature reaches 60°C, trigger point of a thermal alarm, the red LED on the front panel will flash and there will be an alarm signal sent out through the PMBus interface (refer to 3.19). Even so, the units still operate normally.
- ⊙ When the internal temperature is within a normal value, there will be a "LOW" signal (-0.5 -0.5V) sent out through T-ALARM on CN1; there will be a "HIGH" signal (3.5 -5.5V) sent out through T-ALARM on CN1 when internal temperature exceeds a certain value. (referenced to GND-AUX).
- ⊙ Maximum output current: 10mA.

3.10 AC OK signal

- ⊙ Built-in AC input voltage detection circuit.
- ⊙ When AC input voltage $\geq 87V_{rms}$, the output voltage can start working normally and there will be a "HIGH" signal(3.5-5.5V) sent out through AC-OK on CN1. (referenced to GND-AUX).
- ⊙ When AC input voltage $\leq 75V_{rms}$, The output voltage shuts off and the red LED on the fron panel will light up. In the mean time, there will be a "LOW" signal (-0.5-0.5V) sent out through AC-OK on CN1. (referenced to GND-AUX).
- ⊙ Maximum output current 10mA.

3.11 DC OK signal

- ⊙ Built-in DC output voltage detection circuit.
- ⊙ When DC output voltage is within a normal value, there is a "LOW"(-0.5-0.5V) signal sent out through DC-OK on CN1. (referenced to GND-AUX).
- ⊙ When DC output voltage is out of normal range, there is a "HIGH"(3.5-5.5V) signal sent out through DC-OK on CN1. (referenced to GND-AUX).
- ⊙ Maximum output current 10mA.

3.12 Fan-lock Protection & Alarm Signals

- ⊙ Built-in fan-lock protection circuit, the output will shut off when the DC fans stop operating (fan-lock or broken wires). In the meantime, there will be a "HIGH" signal sent out through T-ALARM, referenced to GND-AUX. Please remove the unit from your system and send back to our local distributor or MEAN WELL for repair.
- ⊙ Maximum output current 10mA.

3.13 Remote Control

- ⊙ Built-in remote ON/OFF control circuit, refer to Figure3-3 for control methods of single unit or whole rack system.
- ⊙ Please be aware that "ON/OFF" and "+5V-AUX" on CN1 should be linked together to allow the units operate normally; If kept open, there will be no output voltage.
- ⊙ Maximum input voltage 5.5V.

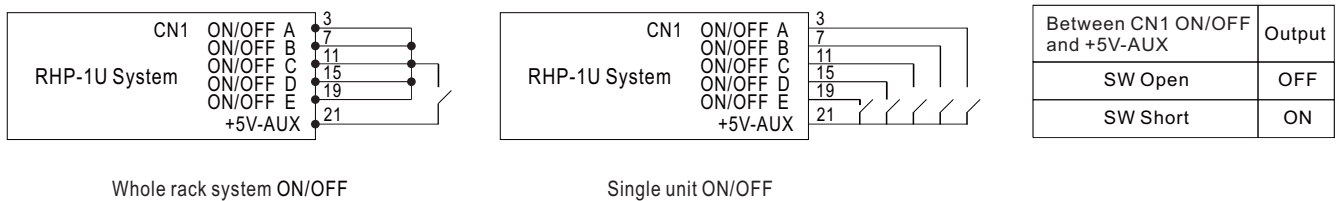

Figure 3-3 Connection of Remote Control

3.14 Remote Sense (only for RCP-1600)

- ⊙ Built-in remote sense circuit that is able to compensate voltage drop up to 0.5V.
- ⊙ When using this function, the sensing wires should either be twisted or shielded to prevent external noise interference (refer to Figure 3-4).
- ⊙ Voltage drop across the output wires must be limited to less than 0.5V. Also wires with adequate current rating should be used between +V, -V and the loads. Please firmly connect the output wires to prevent them from losing, or the power supply may be out of order.
- ⊙ The +S and -S have to be connected to the +V(signal) and -V(signal), respectively, as shown in Figure 3-5, which is Local Sense, in order to get the correct output voltage if Remote Sense is not used. Otherwise, the output voltage will increase to a extremely high level which may trigger OVP.

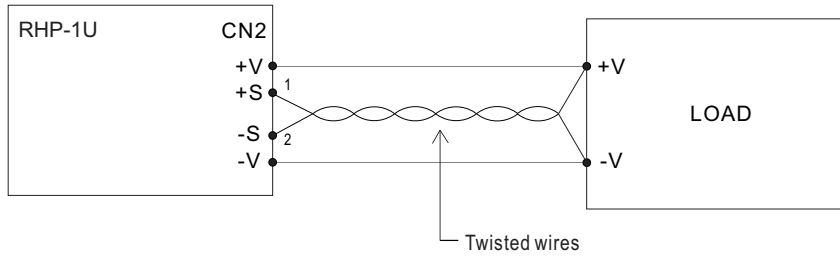

Figure 3-4 Connection of Remote Sense

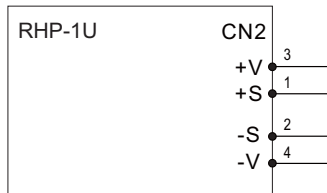

Figure 3-5 Connection of Local Sense

3.15 Hot Swap Operation

- ⊙ Built-in "Oring MOSFET", the units can be installed/removed without tuning power off.
- ⊙ Insert units: Grasp the handle and push into the rack shelf through the rail.

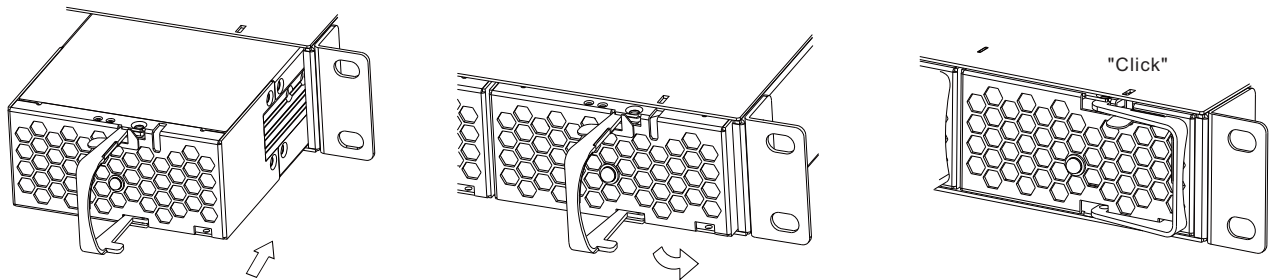

Figure 3-6 Illustration of how to insert the RCP/RCB-1600 into a rack

- ⊙ Pull out units: Press the clip shown in Figure 3-7 and pull it out.

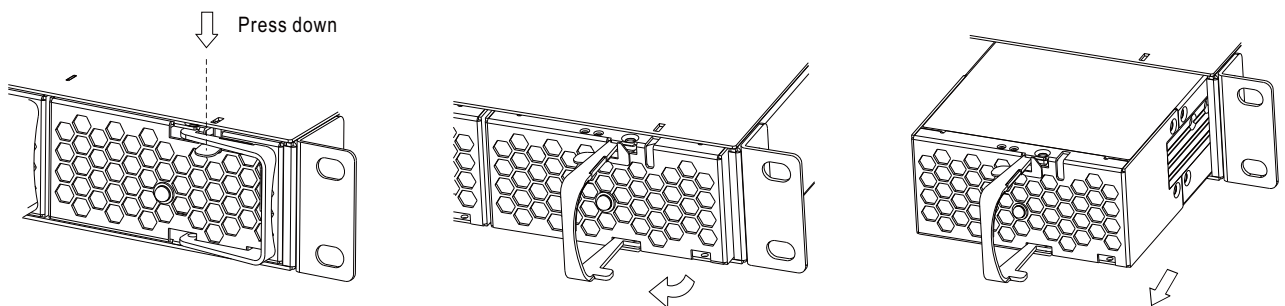

Figure 3-7 Illustration of how to remove the RCP/RCB-1600 from a rack

Caution: Please use adequate force to insert the RCP/RCB-1600 into the rack shelf. Slamming units into the rack can damage the connectors both on the rear of the units and inside the rack.

3.16 Parallel Operation

3.16.1 Operation of Single Rack Shelf

- ⊙ Parallel operation in a single rack shelf is only suitable for the identical units (with the same model and the same output voltage/current).
- ⊙ Each rack shelf (RHP-1U□) has built-in parallel connection/wiring. Once have RCP or RCB units inserted in the rack shelf then these front end unit are operated in parallel.
- ⊙ Please refer to 3.13 & 3.14 for the connection/wiring of other functions.

3.16.2 Operation of three rack shelves in parallel (RCP-1600 system)

- ⊙ Parallel operation is only suitable for the identical units (with the same model and the same output voltage/current). Up to 3 rack shelves and the maximum supply units that can be connected in parallel is 15.
- ⊙ Because of component tolerance, there is a possibility that some of the units connected in parallel will reach an overcurrent limiting then overloading the other units when operating at full load condition. It is suggested that reduce the total output current by 10%.
For example: RCP-1600-24x15 connected in parallel (in 3 rack shelves), the total output current should be reduced to $67A \times 15 \text{ units} \times 0.9 = 904.5A$.
- ⊙ Difference of output voltage among parallel units should be less than 0.2V.
- ⊙ Configure rack shelf units in parallel before connecting to the load. Do not connect rack shelf units to the load separately. Refer to Figure 3-8
- ⊙ Control singles of DA, DB and -V should also be connected in parallel. (Refer to Figure 3.8).
- ⊙ Use twisted wires for the wiring of +S and -S, the twisted wires should not touch the load wires to avoid interference. Refer to Figure 3-8.
- ⊙ A too long cable length might be with a higher amount of noise that affects rack units' proper operation in parallel. To reduce the noise, installing termination resistors, an accessory, to the unused JK1 is recommended.

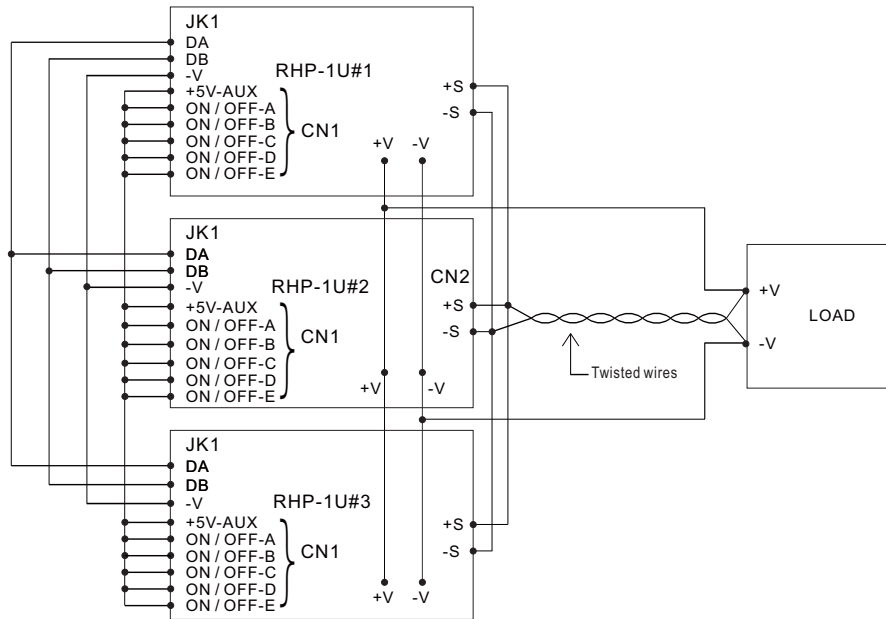

Figure 3-8 Configuration of three rack shelf units in parallel

- ⊙ Under operation of more than one rack shelf in parallel, value of Ripple & Noise may be larger than that stated in the specification at light load or no condition. It will return to normal level once the loads draw more current than 10% of the total rating.

3.17 Series Operation

- ⊙ Higher output voltage can be acquired by connecting rack shelves in series.
- ⊙ The rack shelves (RHP-1U□) connected in series should have the identical units. Please refer to Figure 3-9 for wiring configuration.
- ⊙ Total output current should not exceed currents that can be produced in each rack shelf.
- ⊙ Difference of rise time in each unit may lead to steps/stairs like turn on.
- ⊙ The total amount of output voltage in series should be less than 60Vdc [the requirement of SELV (Safety Extra Low Voltage) of IEC60950-1].
- ⊙ It is suggested that add external diodes (*) on the output, shown in Figure 3-9, to prevent reverse voltage. Rating of these diodes should be higher than the total amount of output voltage and current.

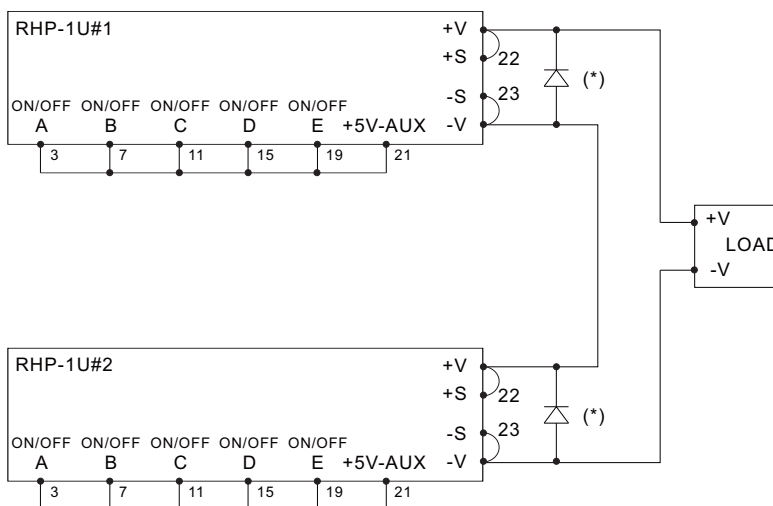

Figure 3-9 Configuration of rack shelf units in series

3.18 Auxiliary Output

- ⊙ Built-in 5V/0.3A and 12V/0.8A auxiliary output.

4. Communication Protocol

Users can use three different methods to control outputs of RCP-1600 and RCB-1600. The control priority between the methods is as follows: Communication (PMBus or CAN bus) > PV/PC > SVR. These three control methods can be used interchangeably. When using communication control, it is essential to communicate with the device within 4 seconds. Otherwise, the program will reset the control priority and set the communication parameters back to the factory default values(NOTE 1). However, the following condition will bypass this control logic: setting RCB-1600 to charger mode. In charger mode, PV/PC and SVR controls will become inactive and charging-related settings can only be changed via communication.

NOTE:1. When D0 is set at "1" and communication function is used, some of the parameters will return to the factory default values if any of the conditions happens, AC recycling and communication timeout. Take RCB-1600-12 as an example, command OPERATION becomes ON, Vo and Io change to 12V and 100A.

2. In charger mode, Remote ON/OFF or OPERATION ON/OFF can be used to activate new curve procedures and import parameters and settings for a new curve profile. Additionally, it can also release protections caused by CURVE_CC_TIMEOUT, CURVE_CV_TIMEOUT, or CURVE_TP_TIMEOUT due to timeouts.

4.1 PMBus Communication Interface

4.1.1 RCP-1600 PMBus Communication Interface

- ⊙ RCP-1600 is compliant with PMBus Rev.1.1, the maximum communication speed is 100KHz and it has the capability of identifying up to 16 addressed units.
- ⊙ PMBus communication interface is able to provide the current operating status and information as follows:
 1. Output voltage, current and internal temperature.
 2. Alarm and status.
 3. Manufacturers and model data.
- ⊙ RKP-CMU1 is a monitor unit particularly designed for rack power.
- ⊙ Maximum number that can be monitored by master controller in communication shall be 15 power supplies.

4.1.1.1 RCP-1600 PMBus Addressing

- ⊙ Each RCP-1600 unit should have their unique and own device address to communicate over the PMbus. 7-bit address setting pins are used to assign a device address for a RCP-1600 unit, as shown in the description below.

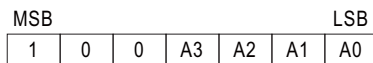

- ⊙ A0-A3 allow users to designate the address for each RCP-1600 unit; these four bits are defined through a 4-pole DIP switch on the rear panel of the rack shelf. There are up to 16 different addresses are available to be assigned. When DIP switch in the "ON" position means logic "0"; when it is in the "OFF" position, meaning logic "1", for example, position 3 in "OFF", the corresponding bit, A2, is set to logic "1". Please refer to Table 4-1 for the detailed setup advice.



Module No.	Device address			
	A0	A1	A2	A3
	DIP switch position			
	1	2	3	4
0	ON	ON	ON	ON
1	OFF	ON	ON	ON
2	ON	OFF	ON	ON
3	OFF	OFF	ON	ON
4	ON	ON	OFF	ON
5	OFF	ON	OFF	ON
6	ON	OFF	OFF	ON
7	OFF	OFF	OFF	ON

Module No.	Device address			
	A0	A1	A2	A3
	DIP switch position			
	1	2	3	4
8	ON	ON	ON	OFF
9	OFF	ON	ON	OFF
10	ON	OFF	ON	OFF
11	OFF	OFF	ON	OFF
12	ON	ON	OFF	OFF
13	OFF	ON	OFF	OFF
14	ON	OFF	OFF	OFF
15	OFF	OFF	OFF	OFF

Table 4-1

4.1.1.2 PMBus Command List

© The command list of the RCP-1600 is shown in Table 4-2. It is compliant with the standard protocol of PMBus Rev. 1.1. For more detailed information, please refer to PMBus official website (<http://pmbus.org/specs.html>).

Command Code	Command Name	Transaction Type	# of data Bytes	Description
01h	OPERATION	R/W Byte	1	Remote ON/OFF control
02h	ON_OFF_CONFIG	Read Byte	1	ON/OFF function configuration
19h	CAPABILITY	Read Byte	1	Capabilities of a PMBus device
20h	VOUT_MODE	R Byte	1	Define data format for output voltage (format: Linear 16, N= -9)
21h	VOUT_COMMAND	R Word	2	Output voltage setting value (format: Linear 16, N= -9)
22h	VOUT_TRIM	R/W Word	2	Output voltage trimmed value
46h	IOUT_OC_FAULT_LIMIT	R/W Word	2	Output overcurrent setting value (format: Linear 11, N= -2)
47h	IOUT_OC_FAULT_RESPONSE	R Byte	1	Define protection and response when an output overcurrent fault occurred
79h	STATUS_WORD	R Word	2	Summary status reporting
7Ah	STATUS_VOUT	R Byte	1	Output voltage status reporting
7Bh	STATUS_IOUT	R Byte	1	Output current status reporting
7Ch	STATUS_INPUT	R Byte	1	AC input voltage status reporting
7Dh	STATUS_TEMPERATURE	R Byte	1	Temperature status reporting
7Eh	STATUS_CML	R Byte	1	Communication, logic, Memory status reporting
80h	STATUS_MFR_SPECIFIC	R Byte	1	Manufacture specific status reporting
81h	STATUS_FANS_1_2	R Byte	1	Fan1 and 2 status reporting
88h	READ_VIN	R Word	2	AC input voltage reading value (format: Linear 11, N=-1)
8Bh	READ_VOUT	R Word	2	Output voltage reading value (format: Linear 16, N= -9)
8Ch	READ_IOUT	R Word	2	Output current reading value (format: Linear 11, N= -2)
8Dh	READ_TEMPERATURE_1	R Word	2	Temperature 1 reading value (format: Linear 11, N= -3)
90h	READ_FAN_SPEED_1	R Word	2	Fan speed 1 reading value (format: Linear 11, N= 5)
91h	READ_FAN_SPEED_2	R Word	2	Fan speed 2 reading value (format: Linear 11, N= 5)
98h	PMBUS_REVISION	R Byte	1	The compliant revision of the PMBus (default: 11h for Rev. 1.1)
99h	MFR_ID	Block Read	12	Manufacturer's name
9Ah	MFR_MODEL	Block Read	12	Manufacturer's model name
9Bh	MFR_REVISION	Block Read	6	Firmware revision
9Ch	MFR_LOCATION	Block R/W	3	Manufacturer's factory location
9Dh	MFR_DATE	Block R/W	6	Manufacture date. (format: YYMMDD)
9Eh	MFR_SERIAL	Block R/W	12	Product serial number

Table 4-2

4.1.1.3 PMBusData Range and Tolerance

◎ Display parameters

PMBus command	Model	Range	Tolerance
READ_VIN	ALL	80 ~ 264V	±10V
READ_VOUT	12V	0 ~ 15V	±0.18V
	24V	0 ~ 30V	±0.36V
	48V	0 ~ 60V	±0.48V
READ_IOUT (Note. 1)	12V	0 ~ 150A	±2.5A
	24V	0 ~ 80A	±1.34A
	48V	0 ~ 40A	±0.67A
READ_TEMPERATURE_1	ALL	-40 ~ 100°C	±5°C
READ_FAN_SPEED_1	ALL	0 ~ 20000RPM	±2000RPM
READ_FAN_SPEED_2	ALL	0 ~ 20000RPM	±2000RPM

Table 4-3

◎ Control parameters

PMBus command	Model	Adjustable range	Tolerance	Default
OPERATION	ALL	00h(OFF) / 80h(ON)	N/A	80h(ON)
VOUT_COMMAND (Note. 2)	12V	12V	N/A	12V
	24V	24V	N/A	24V
	48V	48V	N/A	48V
VOUT_TRIM (Note. 2)	12V	-4.8 ~ 3V	±0.18V	0V
	24V	-14.4 ~ 6V	±0.36V	0V
	48V	-28.8 ~ 12V	±0.48V	0V
IOUT_OC_FAULT_LIMIT	12V	25 ~ 137.5A	±2.5A	137.5A
	24V	13.5 ~ 73.5A	±1.34A	73.5A
	48V	6.75 ~ 36.75A	±0.67A	36.75A

Table 4-4

Note:

1.READ_IOUT will display ZERO amp when output current is less than values in the table below.

Model	Minimum readable current
12V	5A±1A
24V	2.7A±1A
48V	1.3A±1A

Table 4-5

2.When using PMBus to adjust output voltage, VOUT_COMMAND only can be used to display the rated voltage of the unit and cannot be written. It is VOUT_TRIM that sets the amount of trimmed voltage. Taking RCP-1600-12 as an example, to get a 7.2V output, please set value of VOUT_TRIM to -4.8V. Adjustable voltage range for each model is shown as below.

Model	Adjustable voltage
12V	7.2 ~ 15V
24V	9.6 ~ 30V
48V	19.2 ~ 60V

Table 4-6

4.1.2 RCB-1600 PMBus Communication Interface

- ◎ RCB-1600 is compliant with PMBus Rev.1.1, the maximum communication speed is 100KHz and it has the capability of identifying up to 8 addressed units.
- ◎ PMBus communication interface is able to provide the current operating status and data as the following:
 - 1.Output voltage, current and internal temperature.
 - 2.Alarm and status.
 - 3.Manufacturers and model data.
 - 4.Read/write of charge curve settings.

4.1.2.1 PMBus Device Addressing and Charge Mode Selection

Each RCB-1600 unit should have their unique and own device address to communicate over the PMBus. 7-bit address setting pins are used to assign a device address for a RCB-1600 unit, as shown in the below description.

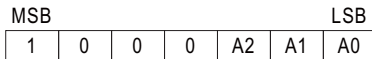

A0-A2 allow users to designate the address for each RCB-1600 unit; these three bits are defined through a 4-pole DIP switch on the rear panel of the rack shelf. There are up to 8 different addresses are available to be assigned. Please refer to Table 4-7(left) for the detailed setup advice.



* The charging operation can be determined by the setup over D0, position 4 on the DIP switch. When D0 is "ON", RCB-1600 follows a built charging curve to charge the batteries; when D0 is "OFF", the charging operation is completely defined by the control over PMBus, PV/PC or SVR. Please refer to Table 4-7(right).

Module No.	Device address		
	A0	A1	A2
	DIP switch position		
	1	2	3
0	ON	ON	ON
1	OFF	ON	ON
2	ON	OFF	ON
3	OFF	OFF	ON
4	ON	ON	OFF
5	OFF	ON	OFF
6	ON	OFF	OFF
7	OFF	OFF	OFF

D0	Function describe
DIP switch position 4	
ON	Charging curve
OFF	PMBus or PV/PC or SVR control

Table 4-7

4.1.2.2 Charge Curve

When it is opted for charging curve, D0 set to ON, charging curve function is enabled with additional PMBus commands. There are 4 built-in charging curves, "default" curve, one pre-defined curve for "gel battery", one pre-defined curve for "flooded battery" and one pre-defined curve for "AGM battery". Each curve can be selected by Command B4h CURVE_CONFIG. Please refer to Table 4-8. In addition, users are able to customize their own charge curves, which will be stored to "default" after modification. Vboost can be set by Command B1h CURVE_VBST ; Vfloat can be set by Command B2h CURVE_VFLOAT ; Charge current level of stage1 can be set by Command B0h CURVE_ICHG; Taper current level from stage2 to stage3 can be set by Command B3h CURVE_ITAPER. Please refer to the following PMBus Command List in 4.1.2.3 for detailed information on commands and parameters.

⊙ Default 3 stage charging curve

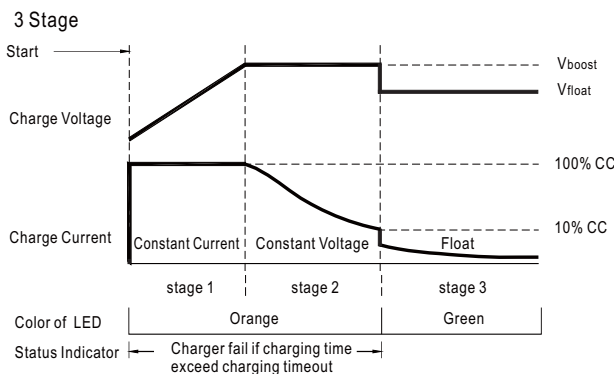

⊙ Suitable for lead-acid batteries (flooded, Gel and AGM) and Li-ion batteries (lithium iron and lithium manganese).

⊙ Embedded 3 stage charging curve

MODEL	Description	Vboost	Vfloat	CC (default)
12V	Default, programmable	14.4	13.8	100A
	Pre-defined gel battery	14	13.6	
	Pre-defined flooded battery	14.2	13.4	
	Pre-defined AGM battery	14.5	13.5	
24V	Default, programmable	28.8	27.6	55A
	Pre-defined gel battery	28	27.2	
	Pre-defined flooded battery	28.4	26.8	
	Pre-defined AGM battery	29	27	
48V	Default, programmable	57.6	55.2	27.5A
	Pre-defined gel battery	56	54.4	
	Pre-defined flooded battery	56.8	53.6	
	Pre-defined AGM battery	58	54	

Table 4-8

Figure 4-1

NOTE: 1. The updated charging parameters is saved into EEPROM. The updated charging curve takes effect after RCB-1600 is restarted, remote on/off, or operation on/off.

2. When charging curve is enabled, the following commands will be invalid while other PMBus commands are effective, Command 22h VOUT_TRIM (regarding Output voltage programming function) and Command 46h IOUT_OC_FAULT_LIMIT (regarding Output current programming function).

4.1.2.3 PMBus Command List

© The command list of the RCB-1600 is shown in Table 4-9. It is compliant with the standard protocol of PMBus Rev. 1.1. For more detailed information, please refer to PMBus official website (<http://pmbus.org/specs.html>).

Table 4-9

Command Code	Command Name	Transaction Type	# of data Bytes	Description
01h	OPERATION	R/W Byte	1	Remote ON/OFF control
02h	ON_OFF_CONFIG	Read Byte	1	ON/OFF function configuration
19h	CAPABILITY	Read Byte	1	Capabilities of a PMBus device
20h	VOUT_MODE	R Byte	1	Define data format for output voltage (format: Linear 16, N= -9)
21h	VOUT_COMMAND	R Word	2	Output voltage setting value (format: Linear 16, N= -9)
22h	VOUT_TRIM	R/W Word	2	Output voltage trimmed value (format: Linear 16, N= -9)
46h	IOUT_OC_FAULT_LIMIT	R/W Word	2	Output overcurrent setting value (format: Linear 11, N= -2)
47h	IOUT_OC_FAULT_RESPONSE	R Byte	1	Define protection and response when an output overcurrent fault occurred
79h	STATUS_WORD	R Word	2	Summary status reporting
7Ah	STATUS_VOUT	R Byte	1	Output voltage status reporting
7Bh	STATUS_IOUT	R Byte	1	Output current status reporting
7Ch	STATUS_INPUT	R Byte	1	AC input voltage status reporting
7Dh	STATUS_TEMPERATURE	R Byte	1	Temperature status reporting
7Eh	STATUS_CML	R Byte	1	Communication, logic, Memory status reporting
80h	STATUS_MFR_SPECIFIC	R Byte	1	Manufacture specific status reporting
81h	STATUS_FANS_1_2	R Byte	1	Fan1 and 2 status reporting
88h	READ_VIN	R Word	2	AC input voltage reading value (format: Linear 11, N= -1)
8Bh	READ_VOUT	R Word	2	Output voltage reading value (format: Linear 16, N= -9)
8Ch	READ_IOUT	R Word	2	Output current reading value (format: Linear 11, N= -2)
8Dh	READ_TEMPERATURE_1	R Word	2	Temperature 1 reading value (format: Linear 11, N= -3)
90h	READ_FAN_SPEED_1	R Word	2	Fan speed 1 reading value (format: Linear 11, N= 5)
91h	READ_FAN_SPEED_2	R Word	2	Fan speed 2 reading value (format: Linear 11, N= 5)
98h	PMBUS_REVISION	R Byte	1	The compliant revision of the PMBus (default: 11h for Rev. 1.1)
99h	MFR_ID	Block Read	12	Manufacturer's name
9Ah	MFR_MODEL	Block Read	12	Manufacturer's model name
9Bh	MFR_REVISION	Block Read	6	Firmware revision
9Ch	MFR_LOCATION	Block R/W	3	Manufacturer's factory location
9Dh	MFR_DATE	Block R/W	6	Manufacture date. (format: YYMMDD)
9Eh	MFR_SERIAL	Block R/W	12	Product serial number

Valid when charging according to charge curve (D0=ON)

Command Code	Command Name	Transaction Type	# of data Bytes	Description
B0h	CURVE_ICHG	R/W Word	2	Constant current setting value of charging curve (format: Linear 11, N= -2)
B1h	CURVE_VBST	R/W Word	2	Constant voltage setting value of charging curve (format: Linear 16, N= -9)
B2h	CURVE_VFLOAT	R/W Word	2	Constant voltage setting value of charging curve (format: Linear 16, N= -9)
B3h	CURVE_ITAPER	R/W Word	2	Taper current setting value of charging curve (format: Linear 11, N= -2)
B4h	CURVE_CONFIG	R/W Word	2	Configuration setting of charging curve
B5h	CURVE_CC_TIMEOUT	R/W Word	2	CC stage timeout setting value of charging curve (format: Linear, N= 0)
B6h	CURVE_CV_TIMEOUT	R/W Word	2	CV stage timeout setting value of charging curve (format: Linear, N= 0)
B7h	CURVE_FLOAT_TIMEOUT	R/W Word	2	Floating timeout setting value of charging curve (format: Linear, N= 0)
B8h	CHG_STATUS	READ Word	2	Charger's status reporting

Note :

⊙ Definition of Command B4h CURVE_CONFIG :

	Bit7	Bit6	Bit5	Bit4	Bit3	Bit2	Bit1	Bit0
High byte	-	-	-	-	-	FVTOE	CVTOE	CCTOE
Low byte	-	STGS	-	-	TCS		CUVS	

Low byte

Bit 1-0 CUVS : Charge Curve Selecting

00= Customized Charge Curve (default)

01= Gel Battery

10= Flooded Battery

11= AGM Battery

Bit 3-2 TCS : Temperature Compensation Setting

00= disable

01= -3 mV/°C/cell (default)

10= -4 mV/°C/cell

11= -5 mV/°C/cell

Bit 6 STGS : 2/3 Stage Charge Setting

0= 3 stage charge (default, CURVE_VBST and CURVE_V FLOAT)

1= 2 stage charge (only CURVE_VBST)

High byte

Bit 0 CCTOE : Constant Current Stage Timeout Indication Enable

0= disabled (default)

1= enabled

Bit 1 CVTOE : Constant Voltage Stage Timeout Indication Enable

0= disabled (default)

1= enabled

Bit 2 FTTOE : Float Stage Timeout Indication Enable

0= disabled (default)

1= enabled

© Definition of Command B8h CHG_STATUS :

	Bit7	Bit6	Bit5	Bit4	Bit3	Bit2	Bit1	Bit0
High byte	FVTOF	CVTOF	CCTOF	-	BTNC	NTCER	-	EEPER
Low byte	-	-	-	-	FVM	CVM	CCM	FULLM

Low byte

Bit 0 FULLM : Fully Charged Mode Status

0=NOT fully charged

1=fully charged

Bit 1 CCM : Constant Current Mode Status

0=the charger NOT in constant current mode

1=the charger in constant current mode

Bit 2 CVM : Constant Voltage Mode Status

0=the charger NOT in constant voltage mode

1=the charger in constant voltage mode

Bit 3 FVM : Float Mode Status

0=the charger NOT in float mode

1=the charger in float mode

High byte

Bit 0 EEPER: EEPROM Charge Parameter Error

0=charge parameter correct

1=charge parameter error

Bit 2 NTCER: Temperature Compensation Status

0=NO short-circuit in the circuitry of temperature compensation

1=the circuitry of temperature compensation has short-circuited

Bit 3 BTNC: Battery Detection

0=battery detected

1=NO battery detected

Bit 5 CCTOF : Time Out Flag Of Constant Current Mode

0=NO time out in constant current mode

1=constant current mode timed out

Bit 6 CVTOF : Time Out Flag Of Constant Voltage Mode

0=NO time out in constant voltage mode

1=constant voltage mode timed out

Bit 7 FTTOF : Time Out Flag Of Float Mode

0=NO time out in float mode

1=float mode timed out

Note:

EEPER : When EEPROM Charge Parameter Error occurs, the charger stops charging the battery and the LED indicator turns red. The charger needs to re-power on to re-start charging the battery.

NTCER : When Temperature Compensation Short occurs, the charger output will shut down and the LED indicator will turn red. The charger will automatically restart after the Temperature Compensation Short condition is removed.

BTNC : When there is no battery detected, the charger stops charging the battery and the LED indicator turns red. The charger needs to re-power on to re-start charging the battery.

CCTOF : When timeout arises in the Constant Current stage, the charger stops charging the battery and the LED indicator turns red. The charger needs to re-power on to re-start charging the battery.

CVTOF : When timeout arises in the Constant Voltage stage, the charger stops charging the battery and the LED indicator turns red. The charger needs to re-power on to re-start charging the battery.

FVTOF : When timeout arises in the Float stage, the charger stops charging the battery and the LED indicator turns green. This charging flow is finished; the charger needs to re-power on to start charging a different battery.

4.1.2.4 PMBus Data Range and Tolerance

◎ Display parameters

PMBus command	Mode	Range	Tolerance
READ_VIN	ALL	80 ~ 264V	±10V
READ_VOUT	12V	0 ~ 15V	±0.18V
	24V	0 ~ 30V	±0.36V
	48V	0 ~ 60V	±0.48V
READ_IOUT (Note.1)	12V	0 ~ 150A	±2.5A
	24V	0 ~ 80A	±1.34A
	48V	0 ~ 40A	±0.67A
READ_TEMPERATURE_1	ALL	-40 ~ 100°C	±5°C
READ_FAN_SPEED_1	ALL	0 ~ 26500RPM	±2000RPM
READ_FAN_SPEED_2	ALL	0 ~ 26500RPM	±2000RPM

Tabel 4-10

◎ Control parameter

PMBus command	Model	Adjustable range	Tolerance	Default
OPERATION	ALL	00h(OFF) / 80h(ON)	N/A	80h(ON)
VOUT_COMMAND (Note.2)	12V	12V	N/A	12V
	24V	24V	N/A	24V
	48V	48V	N/A	48V
VOUT_TRIM (Note.2)	12V	-3 ~ 3V	±0.18V	0V
	24V	-6 ~ 6V	±0.36V	0V
	48V	-12 ~ 12V	±0.48V	0V
CURVE_VBST (Note.3)	12V	9 ~ 15V	±0.18V	14.4V
	24V	18 ~ 30V	±0.36V	28.8V
	48V	36 ~ 60V	±0.48V	57.6V
CURVE_VFLOAT (Note.3)	12V	9 ~ VBST	±0.18V	13.8V
	24V	18 ~ VBST	±0.36V	27.6V
	48V	36 ~ VBST	±0.48V	55.2V
IOUT_OC_FAULT_LIMIT CURVE_ICHG	12V	20 ~ 100A	±2.5A	100A
	24V	11 ~ 55A	±1.34A	55A
	48V	5.5 ~ 27.5A	±0.67A	27.5A
CURVE_ITAPER	12V	5 ~ 30A	±2.5A	10A
	24V	2.75 ~ 16.5A	±1.34A	5.5A
	48V	1.5 ~ 8.25A	±0.67A	2.8A
CURVE_CC_TIMEOUT CURVE_CV_TIMEOUT CURVE_FLOAT_TIMEOUT	ALL	60 ~ 64800 Minute	±5 Minute	600 Minute

Tabel 4-11

Note:

1.READ_IOUT will display ZERO amp when output current is less than values in the table below.

Model	Minimum readable current
12V	5A±1A
24V	2.7A±1A
48V	1.3A±1A

Tabel 4-12

2. When using PMBus to adjust output voltage, VOUT_COMMAND only can be used to display the rated voltage of the unit and cannot be written. It is VOUT_TRIM that provides voltage trimming function. Taking RCB-1600-12 as an example, to get a 9V output, please set value of VOUT_TRIM to -3V. Adjustable voltage range for each model is shown as below.

Model	Adjustable voltage range
12V	9 ~ 15V
24V	18 ~ 30V
48V	36 ~ 60V

Tabel 4-13

3. The value of CURVE_VFLOAT should be set less or equal to CURVE_VBST, if CURVE_VFLOAT is greater than CURVE_VBST, it will be saved as CURVE_VFLOAT = CURVE_VBST in EEPROM.

4.1.3 Notes on PMBus

1. Insert a at least 50msec delay between commands

2. Examples for Format Conversion :

(1) LINEAR16 format : VOUT_COMMAND 、 VOUT_TRIM 、 READ_VOUT 、 CURVE_CV 、 CURVE_FV ◦

Actual voltage = communication reading $V \times 2^N$. There are two definitions in the VOUT_MODE command that refer to N requirements.

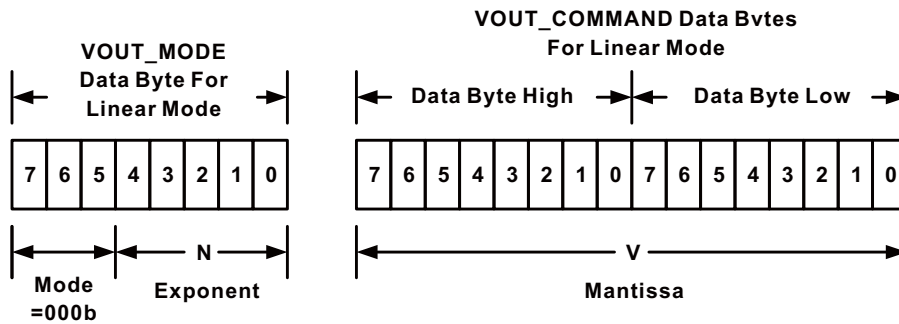

Linear Format Data Bytes

The Mode bits are set to 000b.

The Voltage, in volts, is calculated from the equation:

$$\text{Voltage} = V \cdot 2^N$$

Where:

Voltage is the parameter of interest in volts;

V is a 16 bit unsigned binary integer; and

N is a 5 bit two's complement binary integer.

EX: V_{o_real} (actual output voltage) = $V \times 2^N$, V is from READ_VOUT. N If VOUT_MODE = 0x17, meaning N is -9. READ_VOUT is 0x3000 12288, then $V_{o_real} = 12288 \times 2^{-9} = 24.0V$.

(2) LINEAR11 format : IOUT_OC_FAULT_LIMIT 、 READ_VIN 、 READ_IIN 、 READ_IOUT 、 READ_TEMPERATURE_1 、 READ_FAN_SPEED_1 、 READ_FAN_SPEED_2 、 CURVE_CC 、 CURVE_TC 、 CURVE_CC_TIMEOUT 、 CURVE_CV_TIMEOUT 、 CURVE_FV_TIMEOUT ◦

Actual value X = communication read value $Y \times 2^N$. Among them, the definition of the description column for each aircraft type is referred to.

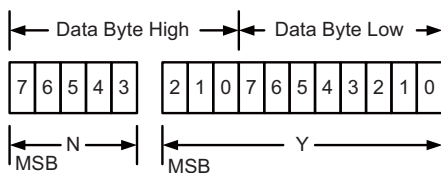

Linear Data Format Data Bytes Y, N and the "real world" value is:

The relation between

$$X = Y \cdot 2^N$$

Where, as described above:

X is the "real world" value;

Y is an 11 bit, two's complement integer; and

N is a 5 bit, two's complement integer.

Devices that use the Linear format must accept and be able to process any value of N.

EX: lo_real (actual output current) = $Y \times 2^N$, Y is from READ_IOUT. N If READ_IOUT is 0xF188h, meaning N is -2 and Y is 0x0188. Y is 0x0188 \rightarrow 392, then $lo_real = 392 \times 2^{-2} = 98.0A$.

4.1.4 Communication Example - Practical Operation of Charger Mode

The following steps will describe how to set the RCB-1600-48 to charger mode and adjust its curve for a 2-stage charging process, with a constant current (CC) of 20A and a constant voltage (CV) of 56V.

1. Set the address of the rack supply to "0", by installing the rack supply in the far right slot or Module A and then setting the SWA DIP switch to ON/ON/ON/ON positions.

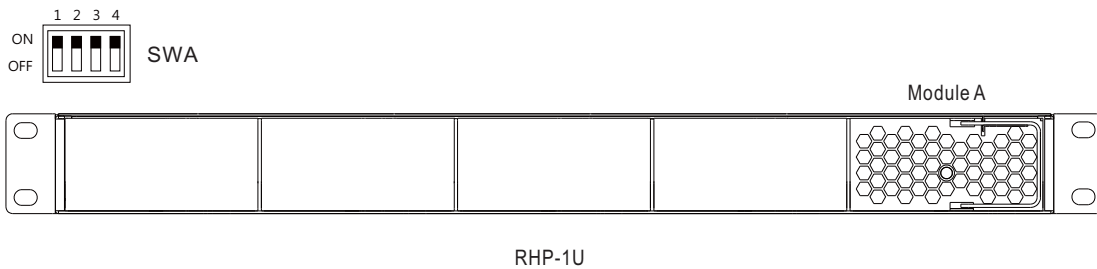

2. Connect the SDA, SCL and GND pins of the master to the corresponding SDA (PIN6), SCL (PIN7) and GND-AUX (PIN8) pins of the JK1 connector on the rack shelf.

Ⓞ Set speed: 100KHz

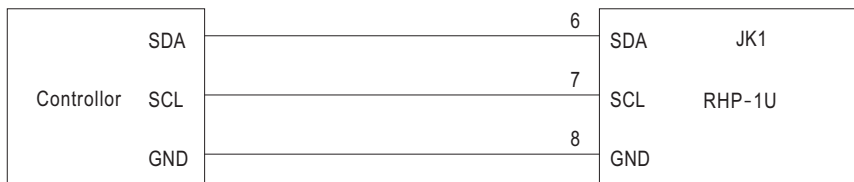

3. Configure communication settings after power on in remote off mode. Enable its charging functionality by setting the rack supply to charger mode and 2-stage charging mode.

Address(7 bit)	Operation	Command Code	Data
0x40	Write	0xB4	0x44, 0x00

Command code: 0xB4(CURVE_CONFIG)

Data: 44(Lo) + 00(Hi) ◦ Please refer to definition of CURVE_CONFIG for detailed information.

4. Set the constant current (CC) point to 20A.

Address(7 bit)	Operation	Command Code	Data
0x40	Write	0xB0	0x50, 0xF0

Command code: 0x00B0(CHURVE_ICHG)

Data: 20A \rightarrow 0x50(Lo) + 0xF0(Hi)

NOTE: CURVE_ICHG is LINEAR11 format

5. Set the constant voltage (CV) point to 56V.

Address(7 bit)	Operation	Command Code	Data
0x40	Write	0xB1	0x00, 0x70

Command code: 0x00B1(CHURVE_VBST)

Data: 56V → 0x00(Lo) + 0x70(Hi)

NOTE: CHURVE_VBST is LINEAR16 format

6. Before connecting to the batteries, it is recommended to review all of the settings and parameters using the appropriate commands. In the event that they do not meet your requirements, you may rewrite them as needed.

EX: Read CHURVE_VBST to check whether CV level or Vboost was set to a proper level.

Read CURVE_VBST

Address(7 bit)	Operation	Command Code
0x40	Read	0xB1

The unit returns data below

Address(7 bit)	Data
0x40	0x00, 0x70

Data: 0x00(Lo) + 0x70(Hi) → 0x7000 → $28672 \times 2^{-9} = 56V$

7. Finally, short circuit ON-OFF (PIN3) and +5-AUX (PIN21) pins of the CN1 connector on the rack shelf to remote on the supply to charge the batteries.

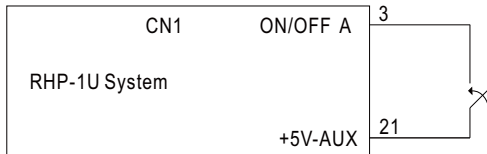

4.2 CANBus Communication Interface

4.2.1 RCP/RCB-1600 CANBus Communication Interface

Physical layer specification

This protocol follows CAN ISO-11898 with Baud rate of 250Kbps.

Data Frame

This protocol uses Extended CAN 29-bit identifier frame format or CAN 2.0B.

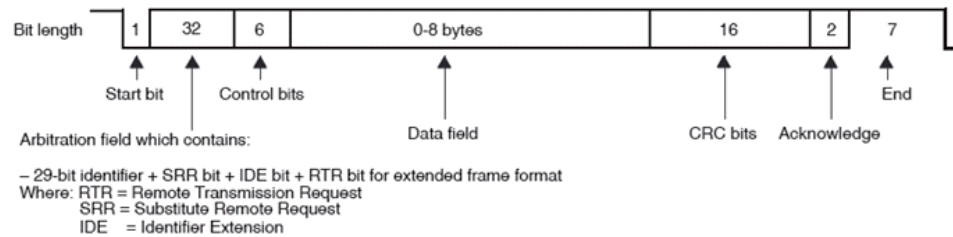

Communication Timing

Min. request period (Controller to RCP/RCB-1600): 50mSec.

Max. response time (RCP/RCB-1600 to Controller): 12.5mSec.

Min. packet margin time (Controller to RCP/RCB-1600): 12.5mSec.

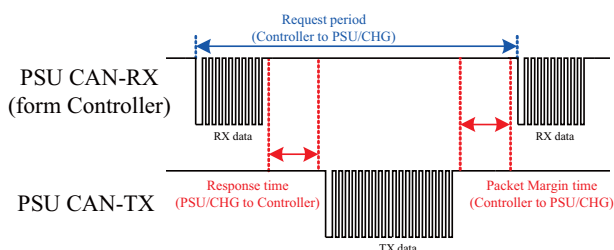

©Data Field Format

Controller to RCP/RCB-1600

Write:

Data filed bytes

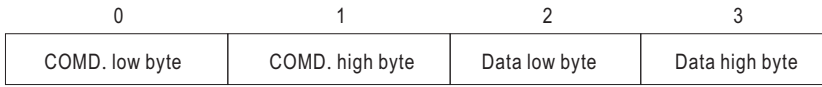

Read:

Data filed bytes

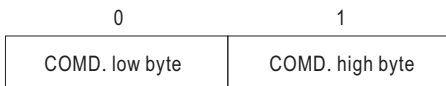

RCP-1600 to Controller

Response:

Data filed bytes

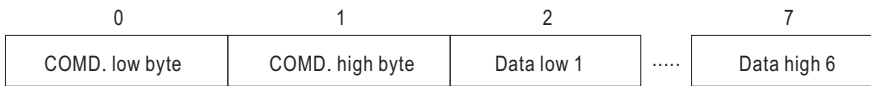

NOTE: RCP/RCB-1600 will not send data back when writing parameters, such as VOUT_SET

4.2.2 RCP-1600 Message ID definition

Message ID	Description
0xC00XX	RCP-1600 to Controller Message ID
0xC01XX	Controller to RCP-1600 Message ID
0xC01FF	Controller broadcasts to RCP-1600

XX means the of RCP-1600

A0-A3 allow users to designate the address for each RCP-1600 unit; these four bits are defined through a 4-pole DIP switch on the rear panel of the rack shelf. There are up to 16 different addresses are available to be assigned. When DIP switch in the "ON" position means logic "0"; when it is in the "OFF" position, meaning logic "1", for example, position 3 in "OFF", the corresponding bit, A2, is set to logic "1". Please refer to Table 4-14 for the detailed setup advice.



Module No.	Device address			
	A0	A1	A2	A3
	DIP switch position			
	1	2	3	4
0	ON	ON	ON	ON
1	OFF	ON	ON	ON
2	ON	OFF	ON	ON
3	OFF	OFF	ON	ON
4	ON	ON	OFF	ON
5	OFF	ON	OFF	ON
6	ON	OFF	OFF	ON
7	OFF	OFF	OFF	ON

Module No.	Device address			
	A0	A1	A2	A3
	DIP switch position			
	1	2	3	4
8	ON	ON	ON	OFF
9	OFF	ON	ON	OFF
10	ON	OFF	ON	OFF
11	OFF	OFF	ON	OFF
12	ON	ON	OFF	OFF
13	OFF	ON	OFF	OFF
14	ON	OFF	OFF	OFF
15	OFF	OFF	OFF	OFF

Table 4-14

4.2.2.1 CANBus Command list

Command Code	Command Name	Transaction Type	# of data Bytes	Description
0x0000	OPERATION	R/W	1	ON/OFF control ON: 01h OFF: 00h
0x0020	VOUT_SET	R/W	2	Output voltage set (format: value, F=0.1)
0x0030	IOUT_SET	R/W	2	Output current set (format: value, F=0.1)
0x0040	FAULT_STATUS	R	2	Abnormal status
0x0050	READ_VIN	R	2	Input voltage read value (format: value, F=1)
0x0060	READ_VOUT	R	2	Output voltage read value (format: value, F=0.1)
0x0061	READ_IOUT	R	2	Output current read value (format: value, F=0.1)
0x0062	READ_TEMPERATURE_1	R	2	Internal ambient temperature (format: value, F=0.1)
0x0070	READ_FAN_SPEED_1	R	2	Fan speed 1 reading value (Format: value, F=1, unit: RPM)
0x0071	READ_FAN_SPEED_2	R	2	Fan speed 2 reading value (Format: value, F=1, unit: RPM)
0x0080	MFR_ID_B0B5	R	6	Manufacture's name
0x0081	MFR_ID_B6B11	R	6	Manufacture's name
0x0082	MFR_MODEL_B0B5	R	6	Manufacture model name
0x0083	MFR_MODEL_B6B11	R	6	Manufacture model name
0x0084	MFR_REVISION_B0B5	R	6	Firmware version
0x0085	MFR_LOCATION_B0B2	R	3	Manufacture place
0x0086	MFR_DATE_B0B5	R	6	Manufacture date
0x0087	MFR_SERIAL_B0B5	R	6	Manufacture serial number
0x0088	MFR_SERIAL_B6B11	R	6	Manufacture serial number

Table 4-15

Note:

The conversion of setting and reading values is defined as following:

Actual value = Communication reading value × Factor (F value). Among them, Factor needs to refer to the definition of SCALING_FACTOR in each model list.

EX: V_{o_real} (actual DC voltage) = READ_VOUT × Factor.

If the Factory of READ_VOUT of a certain mode is 0.1, the communication reading value is 0x00F0

(hexadecimal) → 240(decimal), then $VDC_{real} = 240 \times 0.1 = 24.0V$.

(1)Display parameters

CANBus command	Model	Display value range	Tolerance
READ_VIN	ALL	80~264V	±10V
READ_VOUT	12V	0~15V	±0.18V
	24V	0~30V	±0.36V
	48V	0~60V	±0.48V
READ_IOUT	12V	0~150A	±2.5A
	24V	0~80A	±1.34A
	48V	0~40A	±0.67A
READ_TEMPERATURE_1	ALL	-40~100°C	±5°C
READ_FAN_SPEED_1	ALL	0~26500 RPM	±2000RPM
READ_FAN_SPEED_2	ALL	0~26500 RPM	±2000RPM

(2)Control parameters

CANBus command	Model	Adjustable range	Tolerance	Default
OPERATION	ALL	00h(OFF)/01h(ON)	N/A	ON
VOUT_SET	12V	9~15V	±0.18V	12V
	24V	18~30V	±0.36V	24V
	48V	36~60V	±0.48V	48V
IOUT_IOUT	12V	25~137.5V	±2.5V	137.5A
	24V	13.5~73.5V	±1.34V	73.5A
	48V	6.75~36.75V	±0.67V	36.75A

Note:

1.READ_IOUT will display ZERO amp when output current is less than values in the table below.

Model	Minimum readable current
12V	5A±1A
24V	2.7A±1A
48V	1.3A±1A

4.2.3 RCB-1600 CANBus Communication Interface

4.2.3.1 RCB-1600 Message ID definition

Message ID	Description
0xC00XX	RCB-1600 to Controller Message ID
0xC01XX	Controller to RCB-1600 Message ID
0xC01FF	Controller broadcasts to RCB-1600

XX means ID of a RCB-1600

A0-A2 allow users to designate the ID for each RCB-1600 unit; these three bits are defined through a 4-pole DIP switch on the rear panel of the rack shelf. There are up to 8 different addresses available to be assigned. Please refer to Table 4-16(left) for the detailed setup advice. The charging operation can be determined by the setup over D0, position 4 on the DIP switch. When D0 is "ON", RCB-1600 follows a built charging curve to charge the batteries; when D0 is "OFF", the charging operation is completely defined by the control over PMBus, PV/PC or SVR. Please refer to Table 4-16.



Module No.	Device address		
	A0	A1	A2
	DIP switch position		
	1	2	3
0	ON	ON	ON
1	OFF	ON	ON
2	ON	OFF	ON
3	OFF	OFF	ON
4	ON	ON	OFF
5	OFF	ON	OFF
6	ON	OFF	OFF
7	OFF	OFF	OFF

D0	Function describe
DIP switch position 4	
ON	Charging curve
OFF	PMBus or PV/PC or SVR control

Table 4-16

4.2.3.2 Charge Curve

When it is opted for charging curve, D0 set to ON, charging curve function is enabled with additional CANBus commands. There are 4 built-in charging curves, "default" curve, one pre-defined curve for "gel battery", one pre-defined curve for "flooded battery" and one pre-defined curve for "AGM battery". Each curve can be selected by Command 0x00B4 CURVE_CONFIG. Please refer to Table 4-17. In addition, users are able to customize their own charge curves, which will be stored to "default" after modification. Vboost can be set by Command 0x00B1 CURVE_CV ; Vfloat can be set by Command 0x00B2 CURVE_FV ; Charge current level of stage 1 can be set by Command 0x00B0 CURVE_CC; Taper current level from stage2 to stage3 can be set by Command 0x00B3 CURVE_TC. Please refer to the following CANBus Command List in 4.2.2.3 for detailed information on commands and parameters.

☉ Default 3 stage charging curve

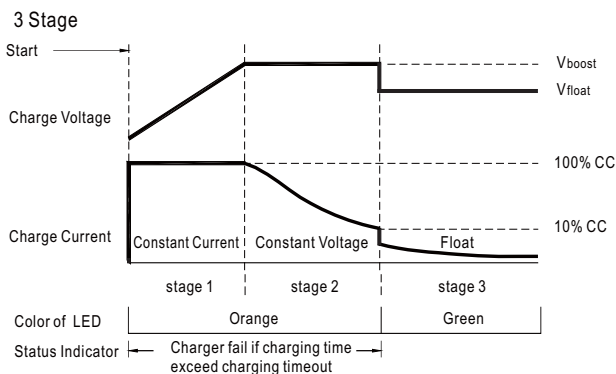

☉ Suitable for lead-acid batteries (flooded, Gel and AGM) and Li-ion batteries (lithium iron and lithium manganese).

☉ Embedded 3 stage charging curve

MODEL	Description	Vboost	Vfloat	CC (default)
12V	Default, programmable	14.4	13.8	100A
	Pre-defined, gel battery	14	13.6	
	Pre-defined, flooded battery	14.2	13.4	
	Pre-defined, AGM battery	14.5	13.5	
24V	Default, programmable	28.8	27.6	55A
	Pre-defined, gel battery	28	27.2	
	Pre-defined, flooded battery	28.4	26.8	
	Pre-defined, AGM battery	29	27	
48V	Default, programmable	57.6	55.2	27.5A
	Pre-defined, gel battery	56	54.4	
	Pre-defined, flooded battery	56.8	53.6	
	Pre-defined, AGM battery	58	54	

NOTE: 1. The updated charging parameters are saved into EEPROM. The updated charging curve takes effect after RCB-1600 is restarted, remote on/off, or operation on/off.

2. When charging curve is enabled, the following commands will be invalid while other CAN bus commands are effective: Command 0x0020 VOUT_SET (regarding Output voltage programming function) and Command 0x0030 IOOUT_SET (regarding Output current programming function).

4.2.3.3 RCB-1600 CANBus Command list

Command Code	Command Name	Transaction Type	# of data Bytes	Description
0x0000	OPERATION	R/W	1	ON/OFF control ON: 01h OFF: 00h
0x0020	VOUT_SET	R/W	2	Output voltage set (format: value, F=0.1)
0x0030	IOUT_SET	R/W	2	Output current set (format: value, F=0.1)
0x0040	FAULT_STATUS	R	2	Abnormal status
0x0050	READ_VIN	R	2	Input voltage read value (format: value, F=1)
0x0060	READ_VOUT	R	2	Output voltage read value (format: value, F=0.1)
0x0061	READ_IOUT	R	2	Output current read value (format: value, F=0.1)
0x0062	READ_TEMPERATURE_1	R	2	Internal ambient temperature (format: value, F=0.1)
0x0070	READ_FAN_SPEED_1	R	2	Fan speed 1 reading value (Format: value, F=1, unit: RPM)
0x0071	READ_FAN_SPEED_2	R	2	Fan speed 2 reading value (Format: value, F=1, unit: RPM)
0x0080	MFR_ID_B0B5	R	6	Manufacture's name
0x0081	MFR_ID_B6B11	R	6	Manufacture's name
0x0082	MFR_MODEL_B0B5	R	6	Manufacture model name
0x0083	MFR_MODEL_B6B11	R	6	Manufacture model name
0x0084	MFR_REVISION_B0B5	R	6	Firmware version
0x0085	MFR_LOCATION_B0B2	R	3	Manufacture place
0x0086	MFR_DATE_B0B5	R	6	Manufacture date
0x0087	MFR_SERIAL_B0B5	R	6	Manufacture serial number
0x0088	MFR_SERIAL_B6B11	R	6	Manufacture serial number
0x00B0	CURVE_CC	R/RW	2	Constant current setting of charge curve (format: value, F=0.1)
0x00B1	CURVE_CV	R/RW	2	Constant voltage setting of charge curve (format: value, F=0.1)
0x00B2	CURVE_FV	R/RW	2	Floating voltage setting of charge curve (format: value, F=0.1)
0x00B3	CURVE_TC	R/RW	2	Taper current setting of charge curve (format: value, F=0.1)
0x00B4	CURVE_CONFIG	R/RW	2	Configuration setting of charge curve
0x00B5	CURVE_CC_TIMEOUT	R/RW	2	CC charge timeout setting of charging curve (format: value, F=1)
0x00B6	CURVE_CV_TIMEOUT	R/RW	2	CV charge timeout setting of charging curve (format: value, F=1)
0x00B7	CURVE_FV_TIMEOUT	R/RW	2	FV charge timeout setting of charging curve (format: value, F=1)
0x00B8	CHG_STATUS	R	2	Charging status reporting

Valid when charging according to charge curve(D0=ON)

Table 4-17

4.2.4 Definition and contents of CANBus Command list

©Definition of Command FAULT_STATUS(0x0040) :

	Bit7	Bit6	Bit5	Bit4	Bit3	Bit2	Bit1	Bit0
Low byte	HI_TEMP	OP_OFF	AC_FAIL	SHORT	OLP	OVP	OTP	FAN_FAIL

Bit 0 FAN_FAIL : Fan locked flag
0 = Working normally
1 = Fan locked

Bit 1 OTP : Over temperature protection
0 = Internal temperature normal
1 = Internal temperature abnormal

Bit 2 OVP : DC over voltage protection
0 = DC voltage normal
1 = DC over voltage protected

Bit 3 OLP : DC over current protection
0 = DC current normal
1 = DC over current protected

Bit 4 SHORT : Short circuit protection
0 = Shorted circuit do not exist
1 = Shorted circuit protected

Bit 5 AC_FAIL : AC abnormal flag
0 = AC input range normal
1 = AC input range abnormal

Bit 6 OP_OFF : DC status
0 = DC output turned on
1 = DC output turned off

Bit 7 HI_TEMP : Internal high temperature protection
0 = Internal temperature normal
1 = Internal temperature abnormal

Note: Unsupported settings displays with "0"

©MFR_ID_B0B5 (0x0080) is the first 6 codes of the manufacturer's name (ASCII); MFR_ID_B6B11 (0x0081) is the last 6 codes of the manufacturer's name (ASCII)

EX: Manufacturer's name is MEANWELL MFR_ID_B0B5 is MEANWE ; MFR_ID_B6B11 is LL

MFR_ID_B0B5					
Byte 0	Byte 1	Byte 2	Byte 3	Byte 4	Byte 5
0x4D	0x45	0x41	0x4E	0x57	0x45

MFR_ID_B6B11					
Byte 0	Byte 1	Byte 2	Byte 3	Byte 4	Byte 5
0x4C	0x4C	0x20	0x20	0x20	0x20

©MFR_MODEL_B0B5 (0x0082) is the first 6 codes of the manufacturer's model name (ASCII);

MFR_MODEL_B6B11 (0x0083) is the last 6 codes of the manufacturer's model name (ASCII)

EX: Model names is RCP-1600-48 → MFR_MODEL_B0B5 is RCP-16 ; MFR_MODEL_B6B11 is 00-48

MFR_MODEL_B0B5					
Byte 0	Byte 1	Byte 2	Byte 3	Byte 4	Byte 5
0x52	0x43	0x50	0x2D	0x31	0x36

MFR_ID_B6B11					
Byte 6	Byte 7	Byte 8	Byte 9	Byte 10	Byte 11
0x30	0x30	0x2D	0x34	0x38	0x20

©MFR_REVISION_B0B5 (0x0084) is the firmware revision (hexadecimal).

A range of 0x00 (R00.0)~0xFE (R25.4) represents the firmware version of an MCU; 0xFF represents no MCU existed.

EX: The supply has two MCUs, the firmware version of the MCU number 1 is version R25.4 (0xFE), the MCU number 2 is version R10.5 (0x69)

Byte 0	Byte 1	Byte 2	Byte 3	Byte 4	Byte 5
0xFE	0x69	0xFF	0xFF	0xFF	0xFF

©MFR_DATE_B0B5 (0x0086) is manufacture date (ASCII)

EX: MFR_DATE_B0B5 is 180101, meaning 2018/01/01

Byte 0	Byte 1	Byte 2	Byte 3	Byte 4	Byte 5
0x31	0x38	0x30	0x31	0x30	0x31

©MFR_SERIAL_B0B5 (0x0087) and MFR_SERIAL_B6B11 (0x0088) are defined as manufacture date and manufacture serial number (ASCII)

EX: The first unit manufactured on 2018/01/01→MFR_SERIAL_B0B5: 180101 ; MFR_SERIAL_B6B11: 000001

Byte 0	Byte 1	Byte 2	Byte 3	Byte 4	Byte 5
0x31	0x38	0x30	0x31	0x30	0x31

Byte 6	Byte 7	Byte 8	Byte 9	Byte 10	Byte 11
0x30	0x30	0x30	0x30	0x30	0x31

©CURVE_CONFIG(0x00B4, only for RCB in charger mode) :

	Bit7	Bit6	Bit5	Bit4	Bit3	Bit2	Bit1	Bit0
High byte	-	-	-	-	-	FVTOE	CVTOE	CCTOE
Low byte	-	STGS	-	-	TCS		CUVS	

Low byte

Bit 0:1 CUVS : Charge Curve Selection

00 = Customized charge Curve(default)

01 = Gel Battery

10 = Flooded Battery

11 = AGM Battery

Bit 3-2 TCS : Temperature Compensation Setting

00 = disable

01 = -3 mV/°C/cell (default)

10 = -4 mV/°C/cell

11 = -5 mV/°C/cell

Bit 6 STGS : 2/3 Stage Charge Setting

0 = 3 stage charge (default)

1 = 2 stage charge

High byte:

Bit 0 CCTOE : Constant Current Stage Timeout Indication Enable

0 = disable (default)

1 = enabled

Bit 1 CVTOE : Constant Voltage Stage Timeout Indication Enable

0 = disable (default)

1 = enabled

Bit 2 FVTOE : Float Voltage Stage Timeout Indication Enable

0 = disable (default)

1 = enabled

Note: Unsupported settings displays with "0"

©CHG_STATUS(0x00B8, only for RCB in charger mode) :

	Bit7	Bit6	Bit5	Bit4	Bit3	Bit2	Bit1	Bit0
High byte	FVTOF	CVTOF	CCTOF	-	BTNC	NTCER	-	EEPER
Low byte	-	-	-	-	FVM	CVM	CCM	FULLM

Low byte

Bit 0 FULLM : Fully Charged Mode Status

0 = NOT fully charged

1 = fully charged

Bit 1 CCM : Constant Current Mode Status

0 = the charger NOT in constant current mode

1 = the charger in constant current mode

Bit 2 CVM : Constant Voltage Mode Status

0 = the charger NOT in constant voltage mode

1 = the charger in constant voltage mode

Bit 3 FVM : Float Mode Status

0 = the charger NOT in float mode

1 = the charger in float mode

High byte:

Bit 0 EEPER: EEPROM charging parameter error

0 = charging parameter is correct

1 = charging parameter has error

Bit 2 NTCER: temperature compensation error

0 = There is no short circuit in the temperature compensation circuitry

1 = There is a short circuit in the temperature compensation circuitry

Bit 3 BTNC : Battery Detection

0 = battery detected

1 = No battery detected

Bit 5 CCTOF : Time Out Flag of Constant Current Mode

0 = NO time out in constant current mode

1 = constant current mode timed out

Bit 6 CVTOF : Time Out Flag of Constant Voltage Mode

0 = NO time out in constant voltage mode

1 = constant voltage mode timed out

Bit 7 FTTOF : Time Out Flag of Float Mod

0 = NO time out in float mode

1 = float mode timed out

4.2.5 CANBus Value Range and Tolerance

(1) Display parameters

CANBus command	Model	Display value range	Tolerance
READ_VIN	ALL	80~264V	±10V
READ_VOUT	12V	0~15V	±0.18V
	24V	0~30V	±0.36V
	48V	0~60V	±0.48V
READ_IOUT	12V	0~150A	±2.5A
	24V	0~80A	±1.34A
	48V	0~40A	±0.67A
READ_TEMPERATURE_1	ALL	-40~100°C	±5°C
READ_FAN_SPEED_1	ALL	0~26500 RPM	±2000RPM
READ_FAN_SPEED_2	ALL	0~26500 RPM	±2000RPM

(2) Control parameters

CANBus command	Model	Adjustable range	Tolerance	Default
OPERATION	ALL	00h(OFF)/01h(ON)	N/A	ON
VOUT_SET	12V	0~15V	±0.18V	12V
	24V	0~30V	±0.36V	24V
	48V	0~60V	±0.48V	48V
IOUT_SET	12V	20~100A	±2.5A	100A
	24V	11~55A	±1.34A	55A
	48V	5.5~27.5A	±0.67A	27.5A
CURVE_CC (RCB only)	12V	20~100A	±2.5A	100A
	24V	11~55A	±1.34A	55A
	48V	5.5~27.5A	±0.67A	27.5A
CURVE_CV (RCB only)	12V	9~15V	±0.18V	28.8A
	24V	18~30V	±0.36V	57.6A
	48V	36~60V	±0.48V	13.8A

CANBus command	Model	Adjustable range	Tolerance	Default
CURVE_FV (RCB only)	12V	9~VBST	±0.18V	13.8A
	24V	18~VBST	±0.36V	27.6A
	48V	36~VBST	±0.48V	55.2A
CURVE_TC (RCB only)	12V	5~30V	±2.5A	10A
	24V	2.75~16.5V	±1.34A	5.5A
	48V	1.5~8.25V	±0.67A	2.8A
CURVE_CC_TIMEOUT CURVE_CV_TIMEOUT CURVE_FV_TIMEOUT (RCB only)	ALL	60~64800 Minute	±5 Minute	600 Minute

Note:

1. READ_IOUT will display ZERO amp when output current is less than values in the table below.

Model	Minimum readable current
12V	5A±1A
24V	2.7A±1A
48V	1.3A±1A

1. The setting of CURVE_FV must be less than or equal to CURVE_CV. If CURVE_FV is greater than CURVE_CV, it will be CURVE_VF=CURVE_CV stored in EEPROM.

4.2.6 Communication example

4.2.6.1 Sending command

The master adjusts output voltage of the unit with address "01" to 30V.

CAN ID	DLC (data length)	Command code	Parameters
0xC0101	0x4	0x2000	0x2C01

Command code: 0x0020 (VOUT_SET) → 0x20(Lo) + 0x00(Hi)

Parameters: 30V → 300 → 0x012C → 0x2C(Lo) + 0x01(Hi)

NOTE: Conversion factor for VOUT_SET is 0.1, so $\frac{30V}{F=0.1} = 300$

4.2.6.2 Reading data or status

The master reads operation setting from the unit with address "00".

CAN ID	DLC (data length)	Command code
0xC0100	0x2	0x0000

The unit with address "00" returns data below

CAN ID	DLC (data length)	Command code	Parameters
0xC0000	0x3	0x0000	0x01

Parameters: 0x01 ON, meaning that the unit with address "00" is operating.

4.2.6.3 Practical Operation of Charger Mode

The following steps will describe how to set the RCB-1600-48 to charger mode and adjust its curve for a 2-stage charging process, with a constant current (CC) of 20A and a constant voltage (CV) of 56V.

1. Set the ID of the rack supply to "0", by installing the rack supply in the far right slot or Module A and then setting the SWA DIP switch to ON/ON/ON/ON positions.

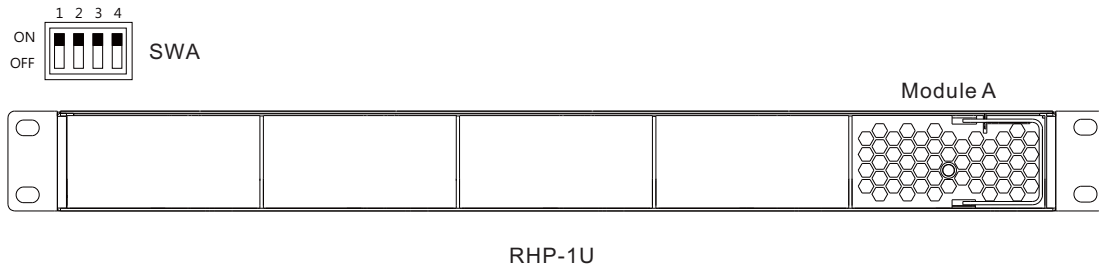

2. Connect the CANH/CANL pins of the master to the corresponding CANH(PIN6) and CANL(PIN7) pins of the JK1 connector on the rack shelf. It is recommended to establish a common ground for the communication system to increase its communication reliability by using GND-AUX (PIN8) of JK1.

Ⓢ Set baud rate: 250kbps, type: extended

Ⓢ Adding a 120Ω terminal resistor to both the controller and rack shelf ends can increase communication stability

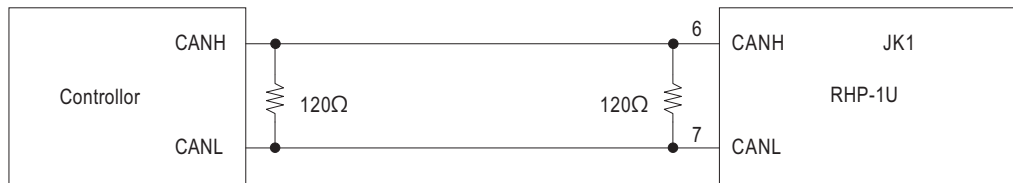

3. Configure communication settings after power on in remote off mode. Enable its charging functionality by setting the rack supply to charger mode and 2-stage charging mode.

CANID	DLC(data length)	Command Code	Parameters
0xC0100	0x04	0x00B4	0x4400

Command code: 0xB4(CURVE_CONFIG)

Data: 44(Lo) + 00(Hi) ◦ Please refer to definition of CURVE_CONFIG for detailed information.

4. Set the constant current (CC) point to 20A

CANID	DLC(data length)	Command Code	Parameters
0xC0100	0x04	0x00B0	0xC800

Command code: 0x00B0(CHURVE_CC)

Data: 20A → 200 → 0x00C8 → 0xC8(Lo) + 0x00(Hi)

NOTE: Conversion factor for CURVE_CC is 0.1, so $\frac{20A}{F=0.1} = 200$

5. Set the constant voltage (CV) point to 56V

CANID	DLC(data length)	Command Code	Parameters
0xC0100	0x04	0x00B4	0x3002

Command code: 0x00B1(CHURVE_CV)

Data: 56V → 560 → 0x0230 → 0x30(Lo) + 0x02(Hi)

NOTE: Conversion factor for CURVE_CV is 0.1, so $\frac{56V}{F=0.1} = 560$

6. Before connecting to the batteries, it is recommended to review all of the settings and parameters using the appropriate commands. In the event that they do not meet your requirements, you may rewrite them as needed.

EX: Read CURVE_CV to check whether CV level or Vboost was set to a proper level.

Read CURVE_CV

CANID	DLC(data length)	Command Code
0xC0100	0x04	0x00B4

The unit returns data below

CANID	DLC(data length)	Command Code	Parameters
0xC0100	0x04	0x00B4	0x3002

Data: 0x02(Lo) + 0x30(Hi) → 0x0230 → 560 = 56V.

7. Finally, short circuit ON-OFF (PIN3) and +5-AUX (PIN21) pins of the CN1 connector on the rack shelf to remote on the supply to charge the batteries.

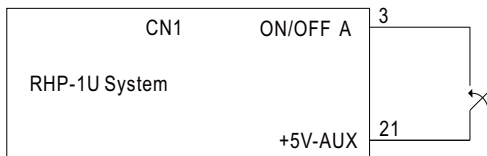

5. Notes on Operation

5.1 Installation Method

- ⊙ Mount the RHP-1U in a 19 inch rack cabinet before operating.
- ⊙ Insert 1 ~ 5 pieces of RCP/RCB-1600 (with the same output voltage and current) into the RHP-1U (refer to Figure 5-1)
- ⊙ This is a unit with forced air cooling, please keep fans and ventilation holes free from any obstructions. It is suggested that there should be no barriers within 10cm of the ventilation holes.
- ⊙ Connect AC source to the AC inlets (A, B, C, D, E) respectively.

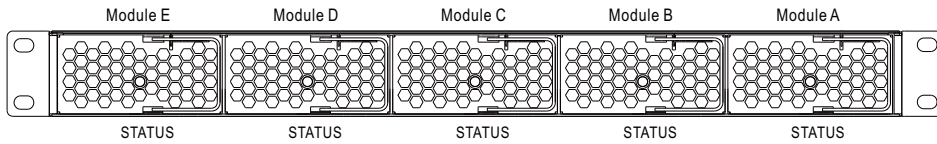

Figure 5-1 RHP System assembly diagram

- ⊙ Suggested wire selection for input/out wirings, e.g. RCP-1600

Input/ Output	Module	Current	Minimum Cross-section of copper wire	Maximum Current
115VAC	1 unit	15Arms	14AWG UL1015	12A
230VAC	1 unit	9Arms	18AWG UL1015	6A
+12VDC	1 unit	125A _{dc}	30mm ²	139A
	2 unit	250A _{dc}	80mm ²	257A
	3 unit	375A _{dc}	150mm ²	395A
	4 unit	500A _{dc}	250mm ²	556A
	5 unit	625A _{dc}	325mm ²	665A
+24VDC	1 unit	67A _{dc}	22mm ²	115A
	2 unit	134A _{dc}	30mm ²	139A
	3 unit	201A _{dc}	60mm ²	217A
	4 unit	268A _{dc}	100mm ²	298A
	5 unit	335A _{dc}	150mm ²	395A
+48VDC	1 unit	33.5A _{dc}	5.5mm ²	49A
	2 unit	67A _{dc}	22mm ²	115A
	3 unit	100.5A _{dc}	30mm ²	139A
	4 unit	134A _{dc}	30mm ²	139A
	5 unit	167.5A _{dc}	50mm ²	190A
Other commonly used wires			16AWG UL1015	8A
			12AWG UL1015	22A
			10AWG UL1015	35A
			30mm ²	139A
			50mm ²	190A
			60mm ²	217A
			80mm ²	257A
			100mm ²	298A
			125mm ²	344A
			150mm ²	395A
			200mm ²	469A
		250mm ²	556A	
		325mm ²	665A	

Table 5-1 Suggested wire selection for input/output wirings

5.2 Derating

⊙ When RCP-1600/RCB-1600 units are operating at a lower AC input voltage, these units will de-rate their output current automatically to protect themselves, shown as Figure 5-2.

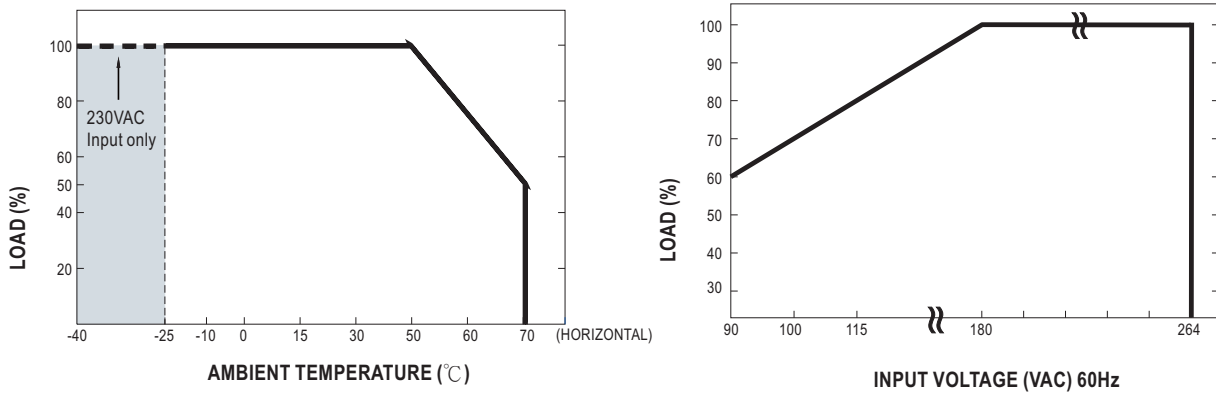

Figure 5-2 Output de-rating curves

5.3 Warranty

⊙ A five year global warranty is provided under normal operation. Please do not change any component or modify the unit by yourself or MEANWELL may reserve the right not to provide the complete warranty service.

明緯企業股份有限公司

MEAN WELL ENTERPRISES CO., LTD.

248 新北市五股區五權三路 28 號

No.28, Wuquan 3rd Rd., Wugu Dist., New Taipei City 248, Taiwan

Tel: 886-2-2299-6100 Fax: 886-2-2299-6200

<http://www.meanwell.com> E-mail: info@meanwell.com

Your Reliable Power Partner